

## *Control Getting Started Guide*

---

# ***Unidrive M700 Unidrive M701 Unidrive HS70 Unidrive HS71***

---

Universal Variable Speed AC drive for  
induction and permanent magnet motors

Part Number: 0478-0239-02  
Issue: 2



**Control Techniques**<sup>™</sup>

---

# Contents

---

<b>1</b>	<b>Safety information</b> .....	<b>3</b>
<b>2</b>	<b>Introduction</b> .....	<b>6</b>
2.1	Operating modes .....	6
<b>3</b>	<b>Control connections</b> .....	<b>8</b>
3.1	Position feedback connections .....	8
3.2	Communications connections .....	10
3.3	Shield connections .....	11
3.4	Control connections .....	12
<b>4</b>	<b>Getting started</b> .....	<b>13</b>
4.1	Quick start commissioning / start-up using Unidrive M Connect (V02.00.00.00 onwards) .....	13
4.3	Keypad / display .....	16
4.4	Keypad operation .....	17
4.5	Menu 0 .....	18
4.6	Menu structure .....	18
4.7	Advanced menus .....	19
4.8	Changing the operating mode .....	20
4.9	Saving parameters .....	21
4.10	Restoring parameter defaults .....	21
4.11	Displaying parameters with non-default values only .....	21
4.12	Displaying destination parameters only .....	21
4.13	Parameter access level and security .....	22
4.14	NV Media Card operation .....	22
4.15	Transferring data .....	25
<b>5</b>	<b>Basic parameters (Menu 0)</b> .....	<b>26</b>
5.1	Parameter descriptions .....	29
<b>6</b>	<b>Running the motor</b> .....	<b>34</b>
6.1	Quick start Connections .....	34
6.2	Quick Start / start-up .....	36
<b>7</b>	<b>Further information</b> .....	<b>46</b>
7.1	Diagnostics .....	46

# 1 Safety information

## 1.1 Warnings, Cautions and Notes



A Warning contains information which is essential for avoiding a safety hazard.



A Caution contains information which is necessary for avoiding a risk of damage to the product or other equipment.

### NOTE

A **Note** contains information, which helps to ensure correct operation of the product.

## 1.2 Electrical safety - general warning

The voltages used in the drive can cause severe electrical shock and/or burns, and could be lethal. Extreme care is necessary at all times when working with or adjacent to the drive. Specific warnings are given at the relevant places in this guide.

## 1.3 System design and safety of personnel

The drive is intended as a component for professional incorporation into complete equipment or a system. If installed incorrectly, the drive may present a safety hazard.

The drive uses high voltages and currents, carries a high level of stored electrical energy, and is used to control equipment which can cause injury.

Close attention is required to the electrical installation and the system design to avoid hazards either in normal operation or in the event of equipment malfunction. System design, installation, commissioning/start-up and maintenance must be carried out by personnel who have the necessary training and experience. They must read this safety information and this User Guide carefully.

The STOP and SAFE TORQUE OFF functions of the drive do not isolate dangerous voltages from the output of the drive or from any external option unit. The supply must be disconnected by an approved electrical isolation device before gaining access to the electrical connections.

**With the sole exception of the SAFE TORQUE OFF function, none of the drive functions must be used to ensure safety of personnel, i.e. they must not be used for safety-related functions.**

Careful consideration must be given to the functions of the drive which might result in a hazard, either through their intended behavior or through incorrect operation due to a fault. In any application where a malfunction of the drive or its control system could lead to or allow damage, loss or injury, a risk analysis must be carried out, and where necessary, further measures taken to reduce the risk - for example, an over-speed protection device in case of failure of the speed control, or a fail-safe mechanical brake in case of loss of motor braking.

The SAFE TORQUE OFF function may be used in a safety-related application. The system designer is responsible for ensuring that the complete system is safe and designed correctly according to the relevant safety standards.

## 1.4 Environmental limits

Instructions in this guide regarding transport, storage, installation and use of the drive must be complied with, including the specified environmental limits. Drives must not be subjected to excessive physical force.

## 1.5 Access

Drive access must be restricted to authorized personnel only. Safety regulations which apply at the place of use must be complied with.

## 1.6 Fire protection

The drive enclosure is not classified as a fire enclosure. A separate fire enclosure must be provided. For further information, refer to the *Drive User Guide*.

## 1.7 Compliance with regulations

The installer is responsible for complying with all relevant regulations, such as national wiring regulations, accident prevention regulations and electromagnetic compatibility (EMC) regulations. Particular attention must be given to the cross-sectional areas of conductors, the selection of fuses or other protection, and protective ground (earth) connections.

This guide contains instruction for achieving compliance with specific EMC standards.

Within the European Union, all machinery in which this product is used must comply with the following directives:

2006/42/EC: Safety of machinery.

2004/108/EC: Electromagnetic Compatibility.

## 1.8 Motor

Ensure the motor is installed in accordance with the manufacturer's recommendations. Ensure the motor shaft is not exposed.

Standard squirrel cage induction motors are designed for single speed operation. If it is intended to use the capability of the drive to run a motor at speeds above its designed maximum, it is strongly recommended that the manufacturer is consulted first.

Low speeds may cause the motor to overheat because the cooling fan becomes less effective. The motor should be installed with a protection thermistor. If necessary, an electric forced vent fan should be used.

The values of the motor parameters set in the drive affect the protection of the motor. The default values in the drive should not be relied upon.

It is essential that the correct value is entered in Pr **00.046** motor rated current. This affects the thermal protection of the motor.

## 1.9 Mechanical brake control

The brake control functions are provided to allow well co-ordinated operation of an external brake with the drive. While both hardware and software are designed to high standards of quality and robustness, they are not intended for use as safety functions, i.e. where a fault or failure would result in a risk of injury. In any application where the incorrect operation of the brake release mechanism could result in injury, independent protection devices of proven integrity must also be incorporated.

## 1.10 Adjusting parameters

Some parameters have a profound effect on the operation of the drive. They must not be altered without careful consideration of the impact on the controlled system. Measures must be taken to prevent unwanted changes due to error or tampering.

## 1.11 Electrical installation

### 1.11.1 Electric shock risk

The voltages present in the following locations can cause severe electric shock and may be lethal:

- AC supply cables and connections
- Output cables and connections
- Many internal parts of the drive, and external option units

Unless otherwise indicated, control terminals are single insulated and must not be touched.

### 1.11.2 Stored charge

The drive contains capacitors that remain charged to a potentially lethal voltage after the AC supply has been disconnected. If the drive has been energized, the AC supply must be isolated at least ten minutes before work may continue.

---

## 2 Introduction

---

This guide covers the *Unidrive M700/HS70* and *Unidrive M701/HS71* products.

### **Unidrive M700/HS70 / Unidrive M701/HS71 features**

- Analog and digital I/O with single channel SAFE TORQUE OFF input
- NV Media Card for parameter copying and data storage
- Universal high performance drive for induction, servo, permanent magnet and linear motors
- Flexibility with speed and position measurement, supporting multiple devices and all common interfaces
- Ethernet fieldbus communication (*Unidrive M700/HS70*)
- Provides an equivalent for *Unidrive SP (Unidrive M701/HS71)*
- 485 serial communication interface (*Unidrive M701/HS71*)

### **2.1 Operating modes**

The drive is designed to operate in any of the following modes:

1. Open loop mode
  - Open loop vector mode
  - Fixed V/F mode (V/Hz)
  - Quadratic V/F mode (V/Hz)
2. RFC - A
  - With position feedback sensor
  - Without position feedback sensor (Sensorless)
3. RFC - S
  - With position feedback sensor
  - Without position feedback sensor (Sensorless)

#### **2.1.1 Open loop mode**

The drive applies power to the motor at frequencies varied by the user. The motor speed is a result of the output frequency of the drive and slip due to the mechanical load. The drive can improve the speed control of the motor by applying slip compensation. The performance at low speed depends on whether V/F mode or open loop vector mode is selected.

##### **Open loop vector mode**

The voltage applied to the motor is directly proportional to the frequency except at low speed where the drive uses motor parameters to apply the correct voltage to keep the flux constant under varying load conditions.

Typically 100 % torque is available down to 1 Hz for a 50 Hz motor.

##### **Fixed V/F mode**

The voltage applied to the motor is directly proportional to the frequency except at low speed where a voltage boost is provided which is set by the user. This mode can be used for multi-motor applications.

Typically 100 % torque is available down to 4 Hz for a 50 Hz motor.

##### **Quadratic V/F mode**

The voltage applied to the motor is directly proportional to the square of the frequency except at low speed where a voltage boost is provided which is set by the user. This mode can be used for running fan or pump applications with quadratic load characteristics or for multi-motor applications. This mode is not suitable for applications requiring a high starting torque.

### 2.1.2 RFC-A mode

Rotor Flux Control for Asynchronous (induction) motors (RFC-A) encompasses closed loop vector control with a position feedback device

#### With position feedback

For use with induction motors with a feedback device installed. The drive directly controls the speed of the motor using the feedback device to ensure the rotor speed exactly as demanded. Motor flux is accurately controlled at all times to provide full torque all the way down to zero speed.

#### Without position feedback (Sensorless)

Sensorless mode provides closed loop control without the need for position feedback by using current, voltages and key motor parameters to estimate the motor speed. It can eliminate instability traditionally associated with open loop control such as operating large motors with light loads at low frequencies.

### 2.1.3 RFC- S

Rotor Flux Control for Synchronous (permanent magnet brushless) motors (RFC-S) provides closed loop control with position feedback device.

#### With position feedback

For use with permanent magnet brushless motors with a feedback device installed.

The drive directly controls the speed of the motor using the feedback device to ensure the rotor speed is exactly as demanded. Flux control is not required because the motor is self excited by the permanent magnets which form part of the rotor.

Absolute position information is required from the feedback device to ensure the output voltage is accurately matched to the back EMF of the motor. Full torque is available all the way down to zero speed.

#### Without position feedback

For use with permanent magnet brushless motors without a feedback device installed.

Flux control is not required because the motor is self excited by the permanent magnets which form part of the rotor.

Full torque is available all the way down to zero speed, with salient motors.

## 3 Control connections

### 3.1 Position feedback connections

The following functions are provided via the 15-way high density D-type connector on the drive:

- Two position feedback interfaces (P1 and P2).
- One encoder simulation output.
- Two freeze trigger inputs (marker inputs).
- One thermistor input.

The P1 position interface is always available but the availability of the P2 position interface and the encoder simulation output depends on the position feedback device used on the P1 position interface.

**NOTE** Refer to the *Drive User Guide* for information regarding the supported feedback devices on the P1 and P2 position interface and the encoder stimulation output.

**Figure 3-1** Location of position feedback connection

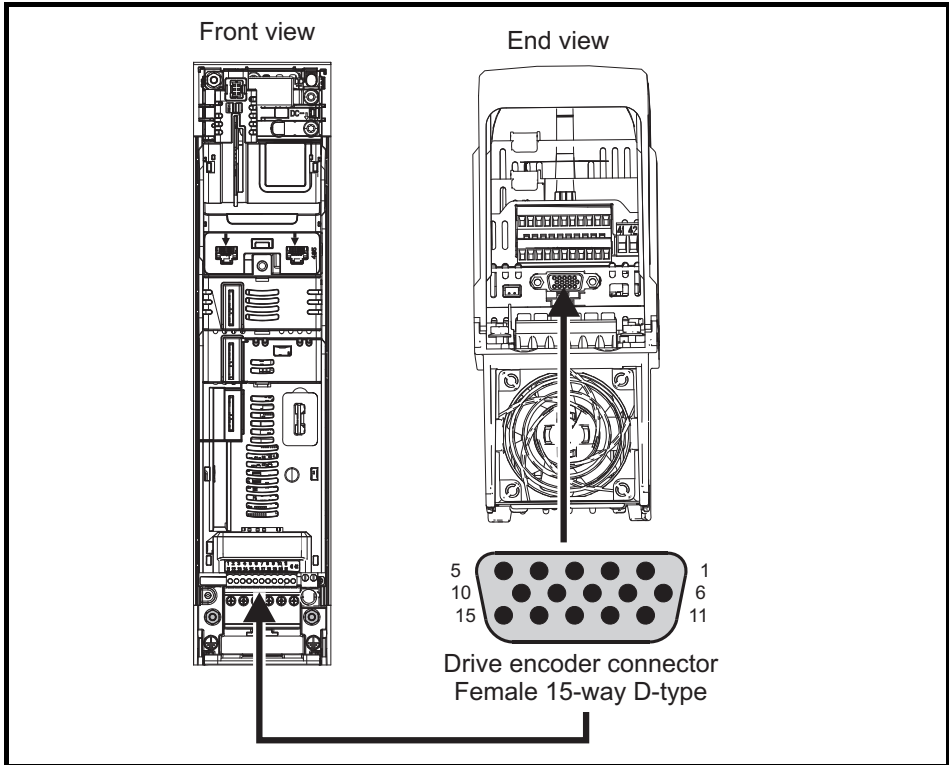



### 3.1.1 Position feedback connection details

**Table 3-1 P1 position feedback connection details**

P1 Position feedback interface Pr 03.038	Connections														
	1	2	3	4	5	6	7	8	9	10	11	12	13	14	15
AB (0)	A	A\	B	B\	Z	Z\							+V <sup>*4</sup>	0 V	Th
FD (1)	F	F\	D	D\	Z	Z\									
FR (2)	F	F\	R	R\	Z	Z\									
AB Servo (3)	A	A\	B	B\	Z	Z\	U	U\	V	V\	W	W\			
FD Servo (4)	F	F\	D	D\	Z	Z\	U	U\	V	V\	W	W\			
FR Servo (5)	F	F\	R	R\	Z	Z\	U	U\	V	V\	W	W\			
SC (6)	A (Cos)	A\ (Cos\)	B (Sin)	B\ (Sin\)	Z	Z\									
SC Hiperface (7)	Cos	Cosref	Sin	Sinref	DATA	DATA\									
EnDat (8)	DATA	DATA\	CLK	CLK\	Frz <sup>*3</sup>	Frz\ <sup>*3</sup>									
SC EnDat (9)	A	A\	B	B\	DATA	DATA\				CLK	CLK\				
SSI (10)	DATA	DATA\	CLK	CLK\	Frz <sup>*3</sup>	Frz\ <sup>*3</sup>									
SC SSI (11)	A (Cos)	A\ (Cos\)	B (Sin)	B\ (Sin\)	DATA	DATA\				CLK	CLK\				
SC Servo (12)	A (Cos)	A\ (Cos\)	B (Sin)	B\ (Sin\)	Z	Z\	U	U\	V	V\	W	W\			
BiSS (13)	DATA	DATA\	CLK	CLK\	Frz <sup>*3</sup>	Frz\ <sup>*3</sup>									
Resolver (14)	Cos H	Cos L	Sin H	Sin L	Ref H	Ref L									
SC SC (15)	A (Cos)	A\ (Cos\)	B (Sin)	B\ (Sin\)	Z	Z\	C <sup>*1</sup>	C\ <sup>*1</sup>	D <sup>*2</sup>	D\ <sup>*2</sup>	Frz2 <sup>*3</sup>	Frz2\ <sup>*3</sup>			
Commutation Only (16)							U	U\	V	V\	W	W\			

\*1 - One sine wave per revolution

\*2 - One cosine wave per revolution

\*3 - Freeze inputs are shown in the table above as 'Frz'.

\*4 - The encoder power supply is selectable through parameter configuration to 5 Vdc, 8 Vdc and 15 Vdc.

Th - Thermistor input.

Greyed cells are for P2 position feedback connections or simulated encoder outputs. Refer to the *Drive User Guide* for further information.

**NOTE** Frz and Frz\ on terminals 5 and 6 are for Freeze input 1. Frz2 and Frz2\ on terminals 11 and 12 are for Freeze input 2.

Control connections
Introduction
<b>Control connections</b>
Getting started
Basic parameters (Menu 0)
Running the motor
Further information

## 3.2 Communications connections

The *Unidrive M700/HS70* product offers Ethernet fieldbus communications and the *Unidrive M701/HS71* offers a 2 wire 485 serial interface. This enables the drive set-up, operation and monitoring to be carried out with a PC or controller if required.

**Figure 3-2 Location of the communication connectors**

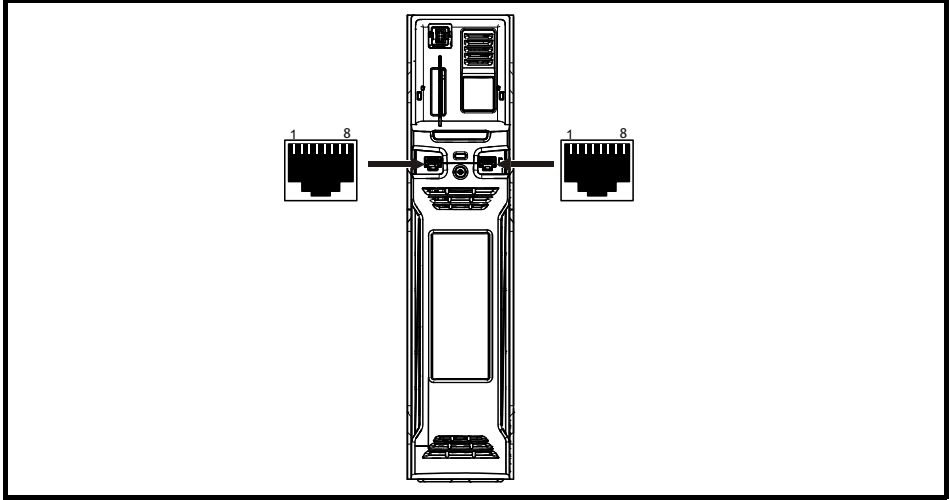

### 3.2.1 Ethernet Fieldbus communications (*Unidrive M700/HS70* only)

The *Unidrive M700/HS70* provides two RJ45 connections with an Ethernet switch for easy network creation.

### 3.2.2 485 Serial communications (*Unidrive M701/HS71* only)

The *Unidrive M701/HS71* provides two parallel RJ45 connectors allowing easy daisy chaining. The drive supports the Modbus RTU protocol. See Table 3-3 for the connection details.

**Figure 3-3 CT Comms cable**

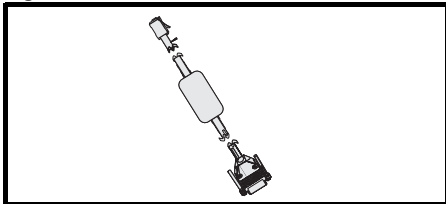

An isolated serial communications lead has been designed to connect the drive to IT equipment (such as laptop computers), and is available from the supplier of the drive. See below for details:

**Table 3-2 Isolated serial comms lead details**

Part number	Description
4500-0096	CT USB Comms cable

The “isolated serial communications” lead has reinforced insulation as defined in IEC60950 for altitudes up to 3,000 m.

**Table 3-3 Serial communication port pin-outs**

Pin	Function
1	120 $\Omega$ Termination resistor
2	RX TX
3	Isolated 0 V
4	+24 V (100 mA)
5	Isolated 0 V
6	TX enable
7	RX\ TX\
8	RX\ TX\ (if termination resistors are required, link to pin 1)
Shell	Isolated 0 V

### 3.3 Shield connections

The following guidelines should be followed to ensure suppression of radio-frequency emission and good noise immunity. It is particularly recommended that the guidelines for the encoder cable be followed closely in order to avoid disturbance to the encoder operation from electrical noise. Use the grounding bracket and grounding clamp supplied with the drive to terminate the shields at the drive.

**Figure 3-4 Grounding of signal cable shields using the grounding bracket**

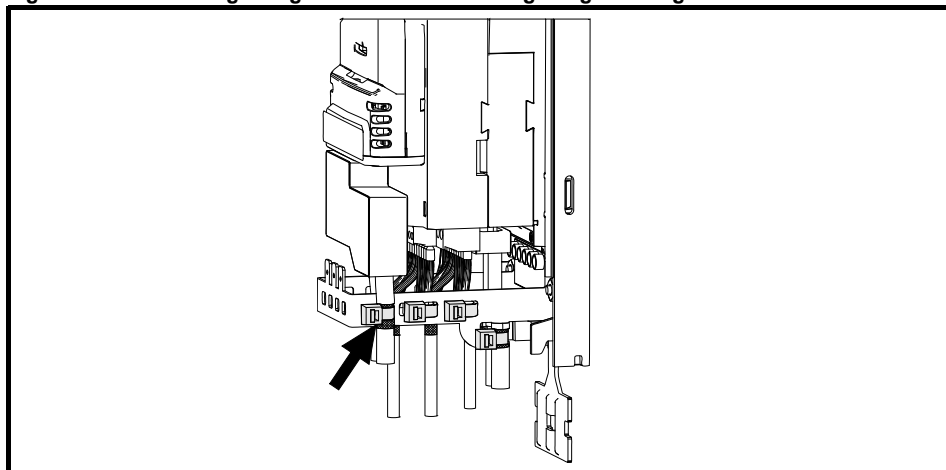

**Motor cable:** Use a motor cable with an overall shield. Connect the shield of the motor cable to the ground terminal of the motor frame using a link that is as short as possible and not exceeding 50 mm (2 in) long. A full 360 ° termination of the shield to the terminal housing of the motor is beneficial.

**Encoder cable:** For best shielding use cable with an overall shield and individual shields on twisted pairs, connect the cable as illustrated in Figure 3-5. Clamp the overall shield to grounded metallic surfaces at both the encoder and the drive.

**Brake resistor cable:** The optional braking resistor should also be wired with shielded cable. If unshielded wire is required refer to the *Drive User Guide* for guidance.

**Control cables:** If the control wiring is to leave the enclosure, it must be shielded and the shield(s) clamped to the drive using the grounding bracket. Remove the outer insulating cover of the cable to ensure the shield(s) make contact with the bracket, but keep the shield(s) intact until as close as possible to the terminals.

**Figure 3-5 Feedback cable shield connections**

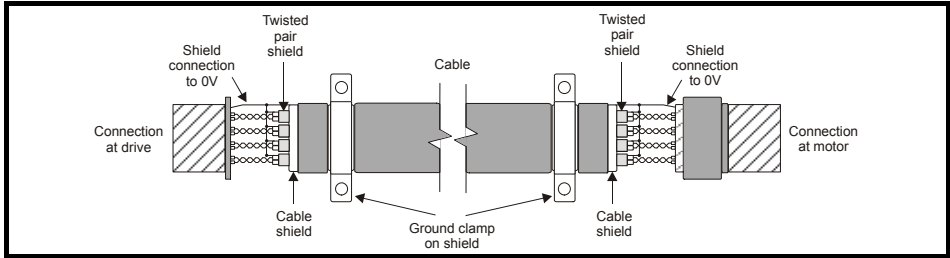

### **3.4 Control connections**

For information on control connections, refer to the back cover of this guide.

## 4 Getting started

### 4.1 Quick start commissioning / start-up using Unidrive M Connect (V02.00.00.00 onwards)

Unidrive M Connect is a Windows™ based software commissioning / start-up tool for Unidrive M/HS. Unidrive M Connect can be used for commissioning / start-up and monitoring, drive parameters can be uploaded, downloaded and compared and simple or custom menu listings can be created. Drive menus can be displayed in standard list format or as live block diagrams. Unidrive M Connect is able to communicate with a single drive or a network. Unidrive M Connect can be downloaded from [www.controltechniques.com](http://www.controltechniques.com) (file size approximately 100 MB).

#### Unidrive M Connect system requirements

- Windows 8, Windows 7 SP1, Windows Vista SP2, Windows XP SP3
- Minimum of 1280 x 1024 screen resolution with 256 colours
- Microsoft.Net Frameworks 4.0 (this is provided in the downloaded file)
- Note that you must have administrator rights to install Unidrive M Connect

Any previous copy of Unidrive M Connect should be uninstalled before proceeding with the installation (existing projects will not be lost). Included within Unidrive M Connect is the *Parameter Reference Guide* for Unidrive M700/701 and Unidrive HS70/HS71.

#### 4.1.1 Power-up the drive

1. Start Unidrive M Connect, and on the 'Project Management' screen select 'Scan serial RTU network' or 'Scan all connected drives'.

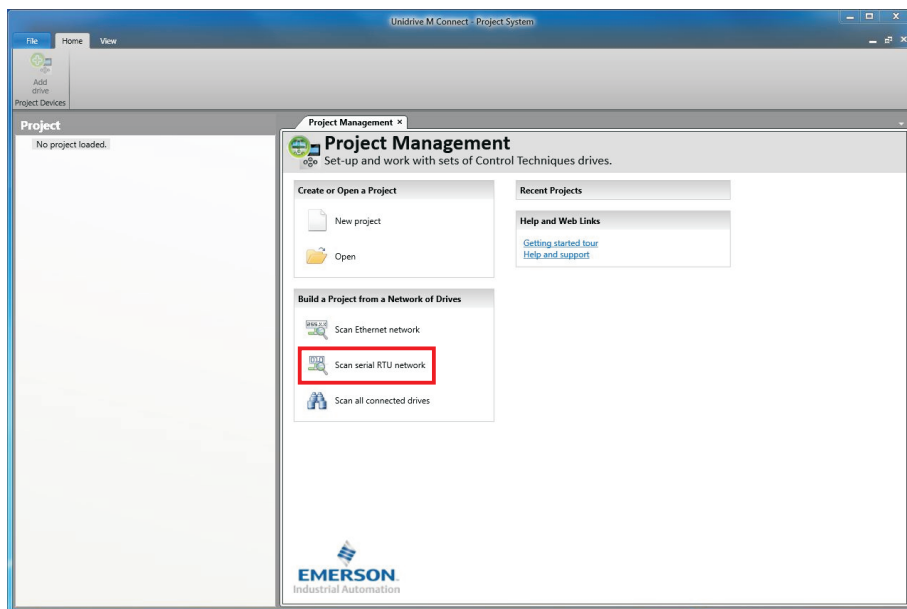

Select the discovered drive.

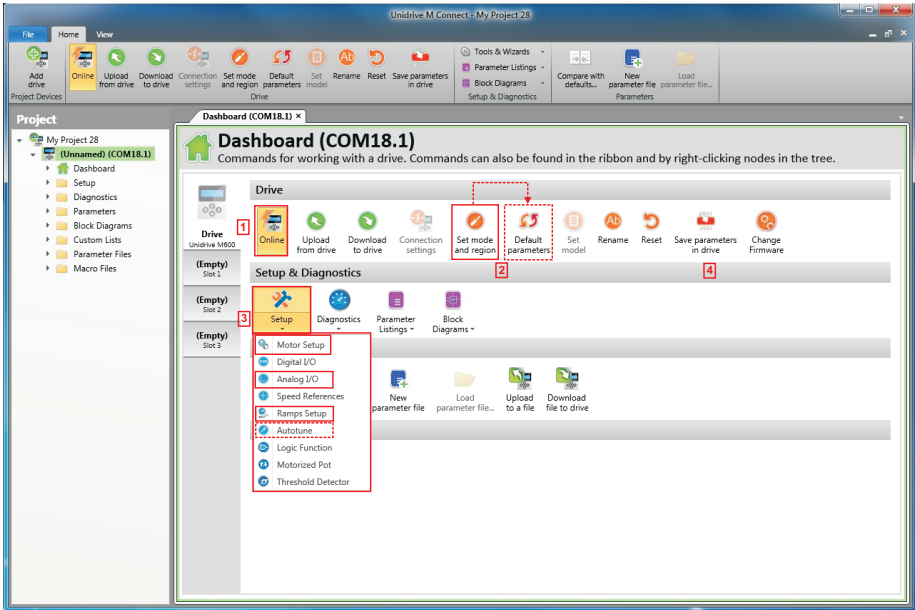

1. Select the 'Online' icon to connect with the drive. When a successful connection is made the icon will be highlighted orange.
2. Select 'Set mode and region'.
  - If the required control mode is highlighted in the 'Drive Settings' dialog, then:
    - Change the supply frequency, if required and select 'Apply', otherwise select 'Cancel'.
    - Select 'Default parameters' from the Dashboard and in the 'Default Parameters' dialogue, select 'Apply'

If the required control mode is not highlighted in the 'Drive Settings' dialog then:

- Select the required mode and supply frequency.
  - Select 'Apply'.
3. Select 'Setup' and perform the steps highlighted (dotted lines indicate a step which may not need to be performed (see below):

Action	Detail
Motor Setup	Unidrive M Connect contains a database for induction motors and permanent magnet motors. Provision is also made to enter motor nameplate data. The next section describes the use of the motor database for a Leroy Somer LSRPM motor used in RFC-S Sensorless mode.
Motor Feedback Setup	<p>This only needs to be performed in RFC-A (with feedback) mode Set Pr <b>03.024</b> = Feedback (0) Enter:</p> <ul style="list-style-type: none"> <li>Encoder power supply in Pr. <b>03.036</b> = 5 V (0), 8 V (1) or 15 V (2). *</li> </ul> <p><b>NOTE</b> If output voltage from the encoder is &gt;5 V, then the termination resistors must be disabled Pr <b>03.039</b> to 0. *</p> <div style="border: 1px solid black; padding: 5px; margin: 5px 0;">  <p>Setting the encoder voltage supply too high for the encoder could result in damage to the feedback device.</p> </div> <ul style="list-style-type: none"> <li>Drive encoder Lines Per Revolution (LPR) in Pr <b>03.034</b> (set according to encoder) *</li> <li>Drive encoder termination resistor setting in Pr <b>03.039</b>: * <ul style="list-style-type: none"> <li>0 = A-A, B-B termination resistors disabled</li> <li>1 = A-A, B-B, termination resistors enabled</li> </ul> </li> </ul> <p>* mm is dependant on the slot into which the SI-Encoder module is installed (15 =Slot 1, 16 = Slot 2, 17 = Slot 3).</p>
Analog I/O	The motor thermistor can be selected in Pr <b>07.015</b> . Refer to the parameter help for Pr <b>07.015</b> for further information.
Ramps Setup	Enter the required Acceleration rate and Deceleration rate Note: If a braking resistor is installed, set 'Ramp mode' to 'Fast'. Also ensure Pr <b>10.030</b> and Pr <b>10.031</b> and Pr <b>10.061</b> are set correctly, otherwise premature 'Brake R Too Hot' trips may be seen).
Autotune	Not required when using data from the motor database for a Leroy Somer LSRPM motor used in RFC-S Sensorless mode.

4. Select 'Save parameters in drive' to perform a parameter save.  
The drive is now ready to run.

## 4.2 Keypad / display

### 4.2.1 Understanding the display

The keypad can only be mounted on the drive.

### 4.2.2 KI-Keypad

The KI-Keypad display consists of two rows of text. The upper row shows the drive status or the menu and parameter number currently being viewed. The lower row of the display line shows the parameter value or the specific trip type. The last two characters on the first row may display special indications. If more than one of these indications is active then the indications are prioritized as shown in Table 4-1 .

When the drive is powered up the lower row will show the power up parameter defined by *Parameter Displayed At Power-up* (11.022).



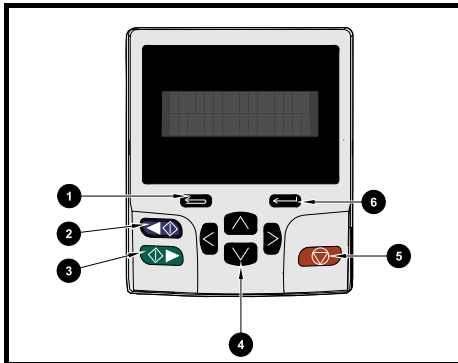





**Figure 4-1 KI-Keypad**



1. Escape button
2. Start reverse (Auxiliary button)
3. Start forward
4. Navigation keys (x4)
5. Stop / Reset (red) button
6. Enter button

**NOTE** The red stop  button is also used to reset the drive.

**Table 4-1 Active action icon**

Active action icon	Description	Row (1=top)	Priority in row
	Accessing non-volatile media card	1	1
	Alarm active	1	2
	Keypad real-time clock battery low	1	3
 or 	Drive security active and locked or unlocked	1	4
	Motor map 2 active	2	1
	User program running	3	1
	Keypad reference active	4	1



## 4.3 Keypad operation

### 4.3.1 Control buttons

The keypad consists of:

- Navigation Keys - Used to navigate the parameter structure and change parameter values.
- Enter / Mode button - Used to toggle between parameter edit and view mode.
- Escape / Exit button - Used to exit from parameter edit or view mode. In parameter edit mode, if parameter values are edited and the exit button pressed the parameter value will be restored to the value it had on entry to edit mode.
- Start forward button - Use to provide a 'Run' command if keypad mode is selected.
- Start reverse button - Used to control the drive if keypad mode is selected and the reverse button is activated.
- Stop / Reset button - Used to reset the drive. In keypad mode can be used for 'Stop'.

Figure 4-2 Display modes

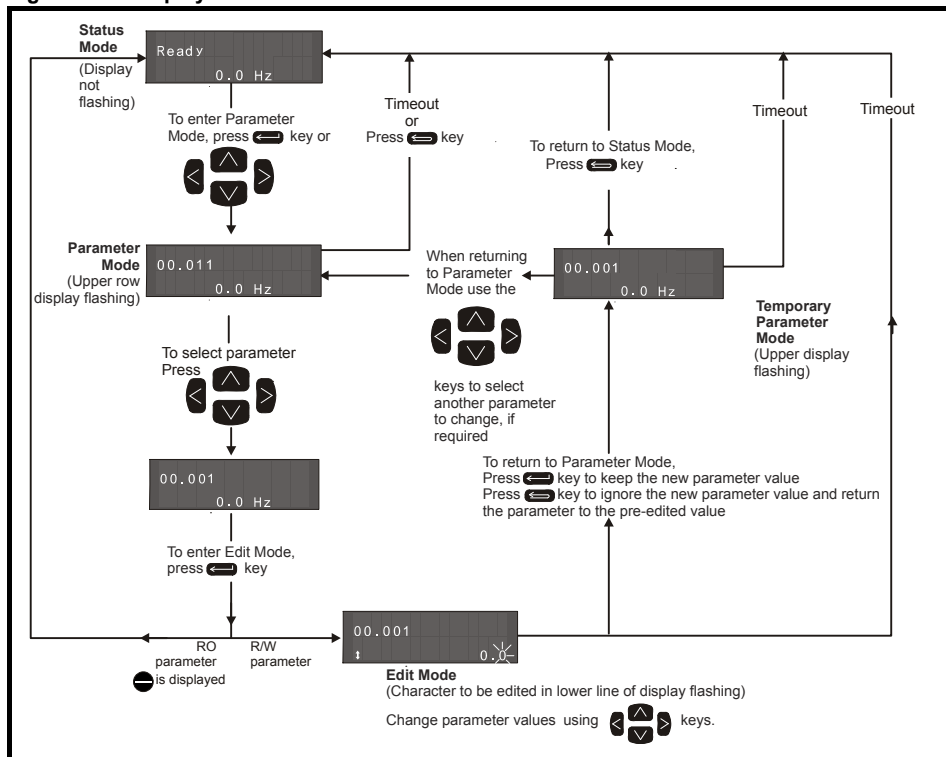

The navigation keys can only be used to move between menus if Pr **00.049** has been set to show 'All Menus'

Figure 4-3 Mode examples

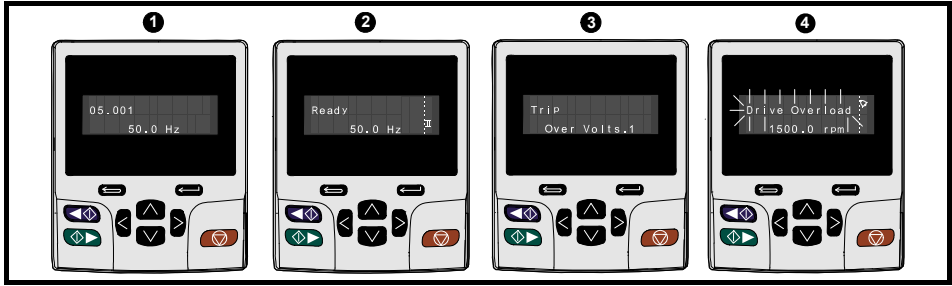

Do not change parameter values without careful consideration; incorrect values may cause damage or a safety hazard.

**NOTE**

When changing the values of parameters, make a note of the new values in case they need to be entered again.

**NOTE**

For new parameter-values to apply after the AC supply to the drive is interrupted, new values must be saved. Refer to section 4.8 *Saving parameters* on page 21.

## 4.4 Menu 0

Menu 0 is used to bring together various commonly used parameters for basic easy set up of the drive. Appropriate parameters are copied from the advanced menus into menu 0 and thus exist in both locations. For further information, refer to Chapter 5 *Basic parameters (Menu 0)* on page 26.

## 4.5 Menu structure

The drive parameter structure consists of menus and parameters. The drive initially powers up so that only Menu 0 can be viewed. The up and down arrow buttons are used to navigate between parameters and once Pr **00.049** has been set to 'All Menus' the left and right buttons are used to navigate between menus. For further information, refer to section 4.12 *Parameter access level and security* on page 22.

Figure 4-4 Menu structure

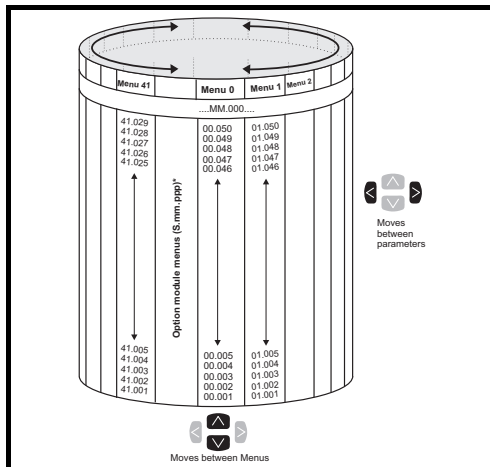

The menus and parameters roll over in both directions. i.e. if the last parameter is displayed, a further press will cause the display to rollover and show the first parameter.

When changing between menus the drive remembers which parameter was last viewed in a particular menu and thus displays that parameter.

\* The option module menus (S.mm.ppp) are only displayed if option modules are installed. Where S signifies the option module slot number and the mm.ppp signifies the menu and the parameter number of the option module's internal menu and parameter.

## 4.6 Advanced menus

The advanced menus consist of groups or parameters appropriate to a specific function or feature of the drive. Menus 0 to 41 can be viewed on the KI-Keypad.

**Table 4-2 Advanced menu descriptions**

Menu	Description
0	Commonly used basic set-up parameters for quick / easy programming
1	Frequency / speed reference
2	Ramps
3	Frequency slaving, speed feedback and speed control
4	Torque and current control
5	Motor control
6	Sequencer and clock
7	Analog I/O, Temperature monitoring
8	Digital I/O
9	Programmable logic, motorized pot, binary sum, timers and scope
10	Status and trips
11	Drive set-up and identification, serial communications
12	Threshold detectors and variable selectors
13	Standard motion control
14	User PID controller
15	Option module slot 1 set-up menu
16	Option module slot 2 set-up menu
17	Option module slot 3 set-up menu
18	General option module application menu 1
19	General option module application menu 2
20	General option module application menu 3
21	Second motor parameters
22	Menu 0 set-up
23	Not allocated
24	Ethernet module (slot 4) set-up menu*
25	Option module slot 1 application parameters
26	Option module slot 2 application parameters
27	Option module slot 3 application parameters
28	Option module slot 4 application parameters
29	Reserved menu
30	Onboard user programming application menu
31-41	Advanced motion controller setup parameters
Slot 1	Slot 1 option menus**
Slot 2	Slot 2 option menus**
Slot 3	Slot 3 option menus**
Slot 4	Ethernet menus*

\* Only applicable to *Unidrive M700/HS70*.

\*\* Only displayed when the option modules are installed.

Safety information

Introduction

Control connections

Getting started

Basic parameters  
(Menu 0)

Running the motor

Further information

## 4.7 Changing the operating mode

Changing the operating mode returns all parameters to their default value, including the motor parameters. *User security status* (00.049) and *User security code* (00.034) are not affected by this procedure).

### Procedure

Use the following procedure only if a different operating mode is required:

1. Ensure the drive is not enabled, i.e. terminal 31 is open or Pr **06.015** is OFF (0)
2. Enter either of the following values in Pr **mm.000**, as appropriate:  
1253 (50Hz AC supply frequency)  
1254 (60Hz AC supply frequency)
3. Change the setting of Pr **00.048** as follows:

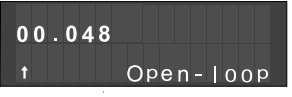
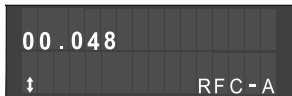
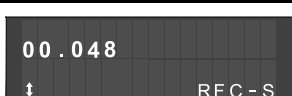
Pr 00.048 setting		Operating mode
	1	Open-loop (Induction motor)
	2	RFC-A (Induction motor with or without position feedback)
	3	RFC-S (Permanent magnet motor with or without position feedback)

The figures in the second column apply when serial communications are used.

4. Either:
  - Press the red  reset button
  - Toggle the reset digital input
  - Carry out a drive reset through serial communications by setting Pr **10.038** to 100.

**NOTE** Entering 1253 or 1254 in Pr **mm.000** will only load defaults if the setting of Pr **00.048** has been changed.

## 4.8 Saving parameters

When changing a parameter in Menu 0, the new value is saved when pressing the  Enter button to return to parameter view mode from parameter edit mode.

If parameters have been changed in the advanced menus, then the change will not be saved automatically. A save function must be carried out.

### Procedure

1. Select 'Save Parameters\*' in Pr **mm.000** (alternatively enter a value of 1000\* in Pr **mm.000**)
2. Either:
  - Press the red  reset button
  - Toggle the reset digital input, or
  - Carry out a drive reset through serial communications by setting Pr **10.038** to 100

\* If the drive is in the under voltage state (i.e. when the control terminal 1 & 2 are being supplied from a low voltage DC supply) a value of 1001 must be entered into Pr **mm.000** to perform a save function.

## 4.9 Restoring parameter defaults

Restoring parameter defaults by this method saves the default values in the drives memory. *User security status* (00.049) and *User security code* (00.034) are not affected by this procedure).

### Procedure

1. Ensure the drive is not enabled, i.e. terminal 31 is open or Pr **06.015** is OFF (0)
2. Select 'Reset 50 Hz Defs' or 'Reset 60 Hz Defs' in Pr **mm.000**. (alternatively, enter 1233 (50 Hz settings) or 1244 (60 Hz settings) in Pr **mm.000**).
3. Either:
  - Press the red  reset button
  - Toggle the reset digital input
  - Carry out a drive reset through serial communications by setting Pr **10.038** to 100

## 4.10 Displaying parameters with non-default values only

By selecting 'Show non-default' in Pr **mm.000** (Alternatively, enter 12000 in Pr **mm.000**), the only parameters that will be visible to the user will be those containing a non-default value. This function does not require a drive reset to become active. In order to deactivate this function, return to Pr **mm.000** and select 'No action' (alternatively enter a value of 0). Please note that this function can be affected by the access level enabled, refer to section 4.9 *Restoring parameter defaults* on page 21 for further information regarding access level.

## 4.11 Displaying destination parameters only

By selecting 'Destinations' in Pr **mm.000** (Alternatively enter 12001 in Pr **mm.000**), the only parameters that will be visible to the user will be destination parameters. This function does not require a drive reset to become active. In order to deactivate this function, return to Pr **mm.000** and select 'No action' (alternatively enter a value of 0).

Please note that this function can be affected by the access level enabled, refer to section 4.12 *Parameter access level and security* on page 22 for further information regarding access level.

## 4.12 Parameter access level and security

The parameter access level determines whether the user has access to Menu 0 only or to all the advanced menus (Menus 1 to 41) in addition to Menu 0. The User Security determines whether the access to the user is read only or read write. Both the User Security and Parameter Access Level can operate independently of each other as shown in Table 4-3.

**Table 4-3 Parameter access level and security**

User security status (11.044)	Access level	User security	Menu 0 status	Advanced menu status
0	Menu 0	Open	RW	Not visible
		Closed	RO	Not visible
1	All Menus	Open	RW	RW
		Closed	RO	RO
2	Read-only Menu 0	Open	RO	Not visible
		Closed	RO	Not visible
3	Read-only	Open	RO	RO
		Closed	RO	RO
4	Status only	Open	Not visible	Not visible
		Closed	Not visible	Not visible
5	No access	Open	Not visible	Not visible
		Closed	Not visible	Not visible

The default settings of the drive are Parameter Access Level Menu 0 and User Security Open i.e. read / write access to Menu 0 with the advanced menus not visible.

## 4.13 NV Media Card operation

### 4.13.1 Introduction

The Non-Volatile Media Card feature enables simple configuration of parameters, parameter back-up and drive cloning using a SMARTCARD or SD card. The drive offers backward compatibility for a Unidrive SP SMARTCARD.

The NV Media Card can be used for:

- Parameter copying between drives
- Saving drive parameter sets
- Saving a program

The NV Media Card is located at the top of the module under the drive display (if installed) on the left-hand side.

Ensure NV Media Card is inserted with the contacts facing the left-hand side of the drive.

The drive only communicates with the NV Media Card when commanded to read or write, meaning the card may be "hot swapped".

Figure 4-5 Installation of the NV Media Card

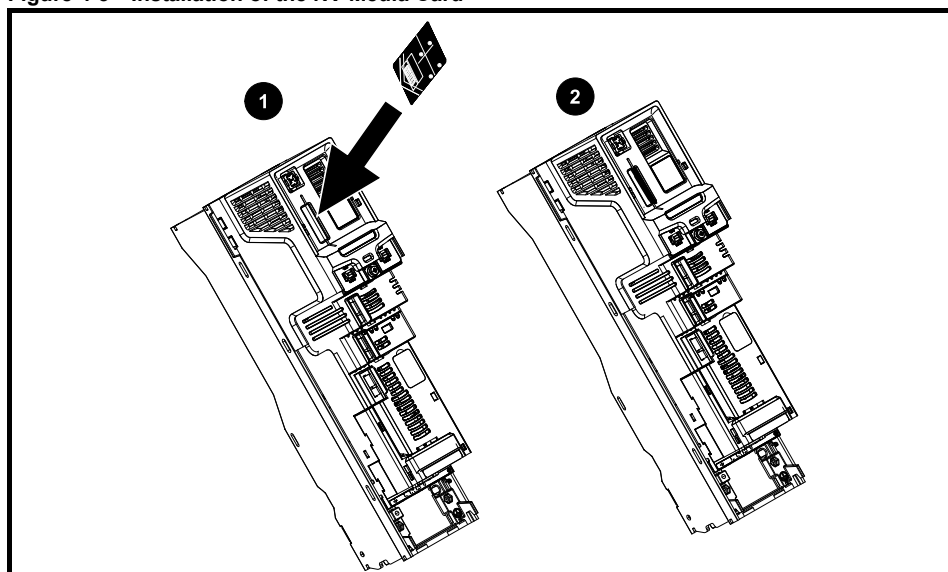

1. Installing the NV Media Card
2. NV Media Card installed

NV Media Card	Part number
SD Card Adaptor (memory card not included)	3130-1212-03
8 kB SMARTCARD	2214-4246-03
64 kB SMARTCARD	2214-1006-03

#### 4.13.2 NV Media Card support

The NV Media Card can be used to store drive parameters and / or PLC programs set from the *Unidrive M/H/S* in data blocks 001 to 499.

The *Unidrive M/H/S* is compatible with a Unidrive SP SMARTCARD and is able to read and translate the Unidrive SP parameter set into a compatible parameter set for *Unidrive M/H/S*. This is only possible if the Unidrive SP parameter set was transferred to the SMARTCARD using the difference from defaults transfer method (i.e. 4yyy transfer). The *Unidrive M/H/S* is not able to read any other type of Unidrive SP data block on the card. Although it is possible to transfer difference from default data blocks from a Unidrive SP into the *Unidrive M/H/S*, the following should be noted:

1. If a parameter from the source drive does not exist in the target drive then no data is transferred for that parameter.
2. If the data for the parameter in the target drive is out of range then the data is limited to the range of the target parameter.
3. If the target drive has a different rating to the source drive then the normal rules for this type of transfer apply.

**Figure 4-6 Basic NV Media Card operation**

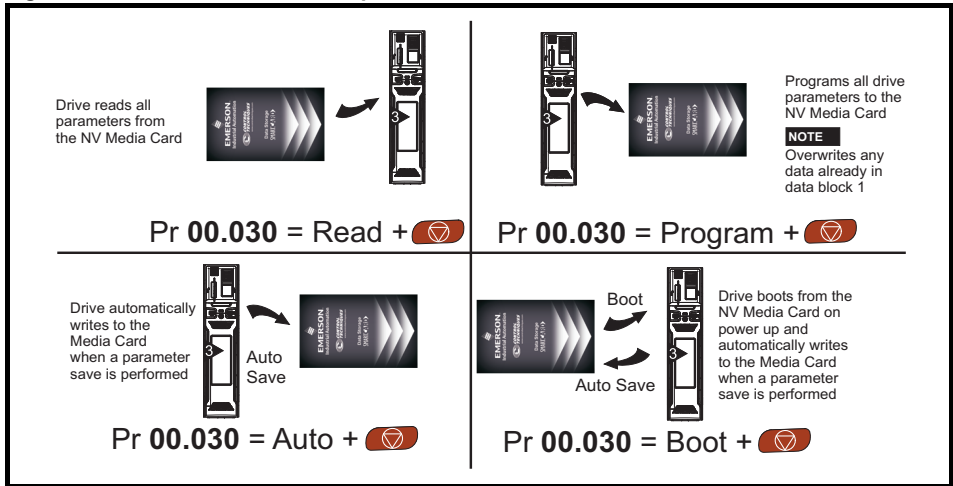

The whole card may be protected from writing or erasing by setting the read-only flag, refer to the *Drive User Guide* for further information.

The card should not be removed during data transfer, as the drive will produce a trip. If this occurs then either the transfer should be reattempted or in the case of a card to drive transfer, default parameters should be loaded.



## 4.14 Transferring data

Data transfer, erasing and protecting the information is performed by entering a code in Pr **mm.000** and then resetting the drive as shown in Table 4-4.

**Table 4-4 SMARTCARD and SD card codes**

Code	Operation	SMARTCARD	SD card
2001	Transfer the drive parameters to parameter file 001 and sets the block as bootable. This will include the parameters from attached option modules.	✓	✓
4yyy	Transfer the drive parameters to parameter file yyy. This will include the parameters from attached option modules.	✓	✓
5yyy	Transfer the onboard user program to onboard user program file yyy.	✓	✓
6yyy	Load the drive parameters from parameter file yyy or the onboard user program from onboard user program file yyy.	✓	✓
7yyy	Erase file yyy.	✓	✓
8yyy	Compare the data in the drive with file yyy. If the files are the same then Pr <b>mm.000 (mm.000)</b> is simply reset to 0 when the compare is complete. If the files are different a 'Card Compare' trip is initiated. All other NV media card trips also apply.	✓	✓
9555	Clear the warning suppression flag	✓	✓
9666	Set the warning suppression flag	✓	✓
9777	Clear the read-only flag	✓	✓
9888	Set the read-only flag	✓	✓
9999	Erase and format the NV media card	✓	✓
15yyy	Transfer a program from an option module in slot 1 to an option module applications file		✓
16yyy	As 15yyy, but for slot 2		✓
17yyy	As 15yyy, but for slot 3		✓
18yyy	Load a program to the option module in slot 1 from an option module applications file		✓
19yyy	As 18yyy, but for slot 2		✓
20yyy	As 18yyy, but for slot 3		✓
21yyy	As 15yyy, but for slot 4		✓
22yyy	As 18yyy, but for slot 4		✓
40yyy	Backup all drive data (parameter differences from defaults, an onboard user program, applications programs and miscellaneous option data), including the drive name; the store will occur to the </MCDF/driveyyy/> folder; if it does not exist, it will be created. Because the name is stored, this is a backup, rather than a clone. The command code will be cleared when all drive and option data have been saved.		✓
60yyy	Load all drive data (parameter differences from defaults, an onboard user program, applications programs and miscellaneous option data); the load will come from the </MCDF/driveyyy/> folder. The command code will not be cleared until the drive and all option data have been loaded.		✓

Safety information

Introduction

Control connections

Getting started

Basic parameters  
(Menu 0)

Running the motor

Further information

# 5 Basic parameters (Menu 0)

Parameter		Range			Default			Type <sup>1</sup>
		OL	RFC-A	RFC-S	OL	RFC-A	RFC-S	
00.001	Minimum Reference Clamp	±VM_NEGATIVE_REF_CLAMP1 Hz / rpm			0.0 Hz	0.0 rpm		RW
00.002	Maximum Reference Clamp	±VM_POSITIVE_REF_CLAMP Hz / rpm			50Hz default: 50.0 Hz 60Hz default: 60.0 Hz	50Hz default: 1500.0 rpm 60Hz default: 1800.0 rpm	3000.0 rpm	RW
00.003	Acceleration Rate 1	±VM_ACCEL_R ATE s /100 Hz	±VM_ACCEL_RATE s /1000 rpm		5.0 s/100 Hz	2.000 s/1000 rpm	0.200 s/1000	RW
00.004	Deceleration Rate 1	±VM_ACCEL_R ATE s /100 Hz	±VM_ACCEL_RATE s /1000 rpm		10.0 s/100 Hz	2.000 s/1000 rpm	0.200 s/1000	RW
00.005	Reference Selector	A1 A2 (0), A1 Preset (1), A2 Preset (2), Preset (3), Keypad (4), Precision (5), Keypad Ref (6)			A1 A2 (0)			RW
00.006	Symmetrical Current Limit	±VM_MOTOR1_CURRENT_LIMIT %			0.0 %			RW
00.007	Open-loop Control Mode	Ur S (0), Ur (1), Fixed (2), Ur Auto (3), Ur I (4), Square (5), Current 1P (6)			Ur I (4)			RW
	Speed Controller Proportional Gain Kp1		0.0000 to 200.000 s/rad			0.0300 s/rad	0.0100 s/rad	RW
00.008	Low Frequency Voltage Boost	0.0 to 25.0 %			Size 3 to 6: 3.0 % Size 7 & 8: 2.0 % Size 9≥: 1.0 %			RW
	Speed Controller Integral Gain Ki1		0.00 to 655.35 s <sup>2</sup> /rad			0.10 s <sup>2</sup> /rad	1.00 s <sup>2</sup> /rad	RW
00.009	Dynamic V to F Select	Off (0) or On (1)			OFF (0)			RW
	Speed Controller Differential Feedback Gain Kd 1		0.00000 to 0.65535 1/rad			0.00000 1/rad		RW
00.010	Motor Rpm	±180000 rpm			0 rpm			RW
	Speed Feedback		±VM_SPEED rpm					RO
00.011	Output Frequency	±VM_SPEED_FREQ_REF Hz						RO
	P1 Position		0 to 65535					RO
00.012	Current Magnitude	±VM_DRIVE_CURRENT_UNIPOLAR A						RO
00.013	Torque Producing Current	±VM_DRIVE_CURRENT A						RO
00.014	Torque Mode Selector	0 or 1	0 to 5		0			RW
00.015	Ramp Mode Select	Fast (0), Standard (1), Std boost (2)	Fast (0), Standard (1)		Standard (1)			RW
00.016	Ramp Enable		OFF (0) or On (1)			On (1)		RW
00.017	Digital Input 6 Destination	00.000 to 30.999			06.031			RW
	Current Reference Filter Time Constant		0.0 to 25.0 ms			0.0 ms		RW

Parameter		Range			Default			Type <sup>1</sup>
		OL	RFC-A	RFC-S	OL	RFC-A	RFC-S	
00.019	Analog Input 2 Mode	4-20 mA Low (-4), 20-4 mA Low (-3), 4-20 mA Hold (-2), 20-4 mA Hold (-1), 0-20 mA (0), 20-0 mA (1), 4-20 mA Trip (2), 20-4 mA Trip (3), 4-20 mA (4), 20-4 mA (5), Volt (6)			Volt (6)			RW
00.020	Analog Input 2 Destination	00.000 to 30.999			01.037			RW
00.021	Analog Input 3 Mode	Volt (6), Therm Short Cct (7), Thermistor (8), Therm No Trip (9)			Volt (6)			RW
00.022	Bipolar Reference Enable	Off (0) or On (1)			OFF(0)			RW
00.023	Jog Reference	0.0 to 400.0 Hz	0.0 to 4000.0 rpm		0.0			RW
00.024	Preset Reference 1	±VM_SPEED_FREQ_REF rpm			0.0			RW
00.025	Preset Reference 2	±VM_SPEED_FREQ_REF rpm			0.0			RW
00.026	Preset Reference 3	±VM_SPEED_FREQ_REF Hz			0.0			RW
	Uni M: Overspeed Threshold				0.0			RW
	Uni HS: Overspeed Threshold							RW
00.027	Preset Reference 4	±VM_SPEED_FREQ_REF Hz			0.0			RW
	P1 Rotary Lines Per Revolution					1024	4096	RW
00.028	Enable Auxiliary Key	0 to 2			0			RW
00.029	NV Media Card Data Previously Loaded	0 to 999						RO
00.030	Parameter copying	None (0), Read (1), Program (2), Auto (3), Boot (4)			None (0)			RW
00.031	Drive Rated Voltage	200 V (0), 400 V (1), 575 V (2), 690 V (3)						RO
00.032	Maximum Heavy Duty Rating	0.000 to 99999.999 A						RO
00.033	Catch A Spinning Motor	Disable (0), Enable (1), Fwd Only (2), Rev Only (3)			Disable (0)			RW
	Motor Parameter Adaptive Control	0 to 2				0		RW
00.034	User Security Code	0 to 2 <sup>31</sup> -1			0			RW
00.035	Serial Mode*	8 2 NP (0), 8 1 NP (1), 8 1 EP (2), 8 1 OP (3), 8 2 NP M (4), 8 1 NP M (5), 8 1 EP M (6), 8 1 OP M (7), 7 2 NP (8), 7 1 NP (9), 7 1 EP (10), 7 1 OP (11), 7 2 NP M (12), 7 1 NP M (13), 7 1 EP M (14), 7 1 OP M (15)			8 2 NP (0)			RW
00.036	Serial Baud Rate*	300 (0), 600 (1), 1200 (2), 2400 (3), 4800 (4), 9600 (5), 19200 (6), 38400 (7), 57600 (8), 76800 (9), 115200 (10)			19200 (6)			RW
00.037	Serial Address*	1 to 247			1			RW
00.037	Active IP Address**	000.000.000.000 to 255.255.255.255						RO
00.038	Current Controller Kp Gain	0 to 30000			20	150		RW
00.039	Current Controller Ki Gain	0 to 30000			40	2000		RW
00.040	Auto-tune	0 to 2	0 to 3	0 to 4	0			RW
00.041	Maximum Switching Frequency	2 kHz (0), 3 kHz (1), 4 kHz (2), 6 kHz (3), 8 kHz (4), 12 kHz (5), 16 kHz (6)			3 kHz (1)		6 kHz (3)	RW
00.042	Number Of Motor Poles	Automatic (0) to 480 Poles (240)			Automatic (0)		6 Poles (3)	RW

Safety information

Introduction

Control connections

Getting started

Basic parameters  
(Menu 0)

Running the motor

Further information

Parameter		Range			Default			Type <sup>1</sup>
		OL	RFC-A	RFC-S	OL	RFC-A	RFC-S	
00.043	Rated Power Factor	0.000 to 1.000			0.850			RW
	Position Feedback Phase Angle			0.0 to 359.9 °				RW
00.044	Rated Voltage	±VM_AC_VOLTAGE_SET			200 V drive: 230 V 50 Hz default 400 V drive: 400 V 60 Hz default 400 V drive: 460 V 575 V drive: 575 V 690 V drive: 690 V			RW
00.045	Uni M: Rated Speed	0 to 33,000 rpm	0.00 to 33,000.00 rpm		50Hz default: 1500 rpm 60Hz default: 1800rpm	50Hz default: 1450 rpm 60Hz default: 1750rpm		RW
	Uni HS: Rated Speed	0 to 180,000 rpm	0 to 50,000 rpm					
	Motor Thermal Time Constant 1				1.0 to 3000.0 s			89.0 s
00.046	Rated Current	±VM_RATED_CURRENT			Maximum Heavy Duty Rating (11.032)			RW
00.047	Uni M: Rated Frequency	0.0 to 550.0 Hz			50Hz default: 50.0 Hz 60Hz default: 60.0 Hz			RW
	Uni HS: Rated Frequency	0.0 to 3000 Hz	0.0 to 1667 Hz					
00.048	Drive Mode	Open-loop (1), RFC-A (2), RFC-S (3), Regen (4)			Open-loop (1)	RFC-A (2)	RFC-S (3)	RW
00.049	User Security Status	Menu 0 (0), All Menus (1), Read-only Menu 0 (2), Read-only (3), Status Only (4), No Access (5)			Menu 0 (0)			RW
00.050	Software Version	0 to 99999999						RO
00.051	Action On Trip Detection	0 to 31			0			RW
00.052	Reset Serial Communications*	Off (0) or On (1)			Off (0)			RW

<sup>1</sup> RW = Read Write, RO = Read Only.

\* Only applicable to *Unidrive M701/HS71*.

\*\* Only applicable to *Unidrive M700/HS70*.

## 5.1 Parameter descriptions

### 5.1.1 Pr mm.000

Pr **mm.000** is available in all menus, commonly used functions are provided as text strings in Pr **mm.000** shown in Table 5-1. The functions in Table 5-1 can also be selected by entering the appropriate numeric values (as shown in Table 5-2) in Pr **mm.000**. For example, enter 7001 in Pr **mm.000** to erase the file in NV media card location 001.

**Table 5-1 Commonly used functions in Pr mm.000**

String	Action
<b>Save parameters</b>	Save parameters when under voltage is not active and low voltage threshold is not active
<b>Load file 1</b>	Load the drive parameters or user program file from NV media card file 001
<b>Save to file 1</b>	Transfer the drive parameters to parameter file 001
<b>Load file 2</b>	Load the drive parameters or user program file from NV media card file 002
<b>Save to file 2</b>	Transfer the drive parameters to parameter file 002
<b>Load file 3</b>	Load the drive parameters or user program file from NV media card file 003
<b>Save to file 3</b>	Transfer the drive parameters to parameter file 003
<b>Show non-default</b>	Displays parameters that are different from defaults
<b>Destinations</b>	Displays parameters that are set
<b>Reset 50 Hz Defs</b>	Load parameters with standard (50 Hz) defaults
<b>Reset 60 Hz Defs</b>	Load parameters with US (60 Hz) defaults
<b>Reset modules</b>	Reset all option modules
<b>Read Enc.NP P1</b>	Transfer electronic nameplate motor parameters to the drive from the P1 encoder
<b>Read Enc.NP P2</b>	Transfer electronic nameplate motor parameters to the drive from the P2 encoder

**Table 5-2 Functions in Pr mm.000**

Value	Action
1000	Save parameters when <i>Under Voltage Active</i> (Pr 10.016) is not active and <i>Low Under Voltage Threshold Select</i> mode (Pr 06.067 = Off) is not active.
1001	Save parameter under all conditions
1070	Reset all option modules
1233	Load standard (50 Hz) defaults
1234	Load standard (50 Hz) defaults to all menus except option module menus (i.e 15 to 20 and 24 to 28)
1244	Load US (60 Hz) defaults
1245	Load US (60 Hz) defaults to all menus except option module menus (i.e 15 to 20 and 24 to 28)
1253	Change drive mode and load standard (50 Hz) defaults
1254	Change drive mode and load US (60 Hz) defaults
1255	Change drive mode and load standard (50 Hz) defaults except for menus 15 to 20 and 24 to 28
1256	Change drive mode and load US (60 Hz) defaults except for menus 15 to 20 and 24 to 28
1299	Reset {Stored HF} trip.
2001*	Create a boot file on a non-volatile media card based on the present drive parameters including all Menu 20 parameters
4yyy*	NV media card: Transfer the drive parameters to parameter file xxx
5yyy*	NV media card: Transfer the onboard user program to onboard user program file xxx
6yyy*	NV media card: Load the drive parameters from parameter file xxx or the onboard user program from onboard user program file xxx
7yyy*	NV media card: Erase file xxx
8yyy*	NV Media card: Compare the data in the drive with file xxx
9555*	NV media card: Clear the warning suppression flag
9666*	NV media card: Set the warning suppression flag
9777*	NV media card: Clear the read-only flag
9888*	NV media card: Set the read-only flag
9999*	NV media card: Erase and format the NV media card
110S0	Transfer electronic nameplate motor object parameters from the drive to an encoder connected to the drive or an option module.
110S1	Transfer electronic nameplate motor objects parameters from an encoder connected to the drive or option module to the drive parameters.
110S2	As 110S0, but for performance object 1
110S3	As 110S1, but for performance object 1
110S4	As 110S0, but for performance object 2
110S5	As 110S1, but for performance object 2
110S6	Transfer electronic nameplate motor object parameters from the drive to an encoder connected to the drive or an option module in the Unidrive SP format.
12000**	Only display parameters that are different from their default value. This action does not require a drive reset.
12001**	Only display parameters that are used to set-up destinations (i.e. DE format bit is 1). This action does not require a drive reset.
15xxx*	Transfer the user program in an option module installed in slot 1 to a non-volatile media card file xxx
16xxx*	Transfer the user program in an option module installed in slot 2 to a non-volatile media card file xxx
17xxx*	Transfer the user program in an option module installed in slot 3 to a non-volatile media card file xxx
18xxx*	Transfer the user program from file xxx in a non-volatile media card to an option module installed in slot 1.
19xxx*	Transfer the user program from file xxx in a non-volatile media card to an option module installed in slot 2.
20xxx*	Transfer the user program from file xxx in a non-volatile media card to an option module installed in slot 3.
21xxx*	Transfer the user program in an option module installed in slot 4 to a non-volatile media card file xxx.
22xxx*	Transfer the user program from file xxx in a non-volatile media card to an option module installed in slot 4.

\* See section 4.13 *NV Media Card operation* on page 22 for more information on these functions.

\*\* These functions do not require a drive reset to become active. All other functions require a drive reset to initiate the function.

Safety information	Introduction	Control connections	Getting started	<b>Basic parameters (Menu 0)</b>	Running the motor	Further information
--------------------	--------------	---------------------	-----------------	--------------------------------------	-------------------	---------------------

Figure 5-1 Menu 0 logic diagram

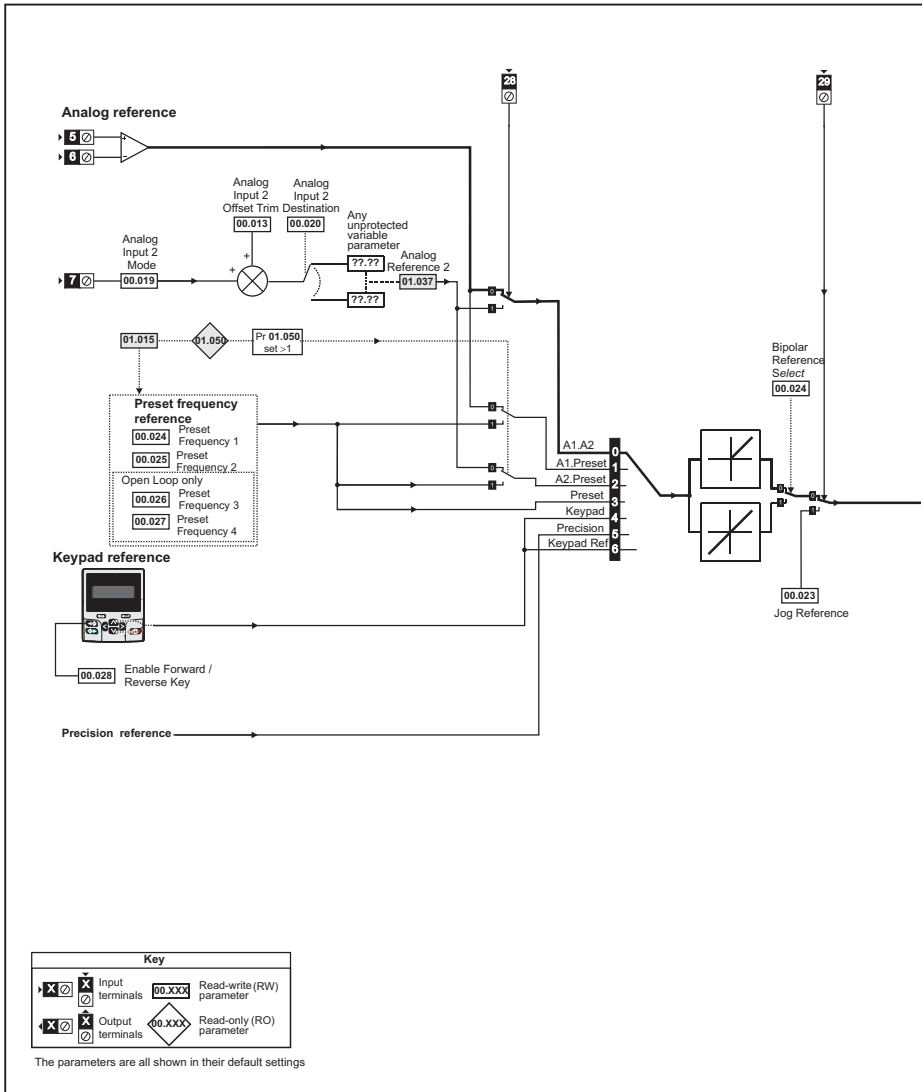



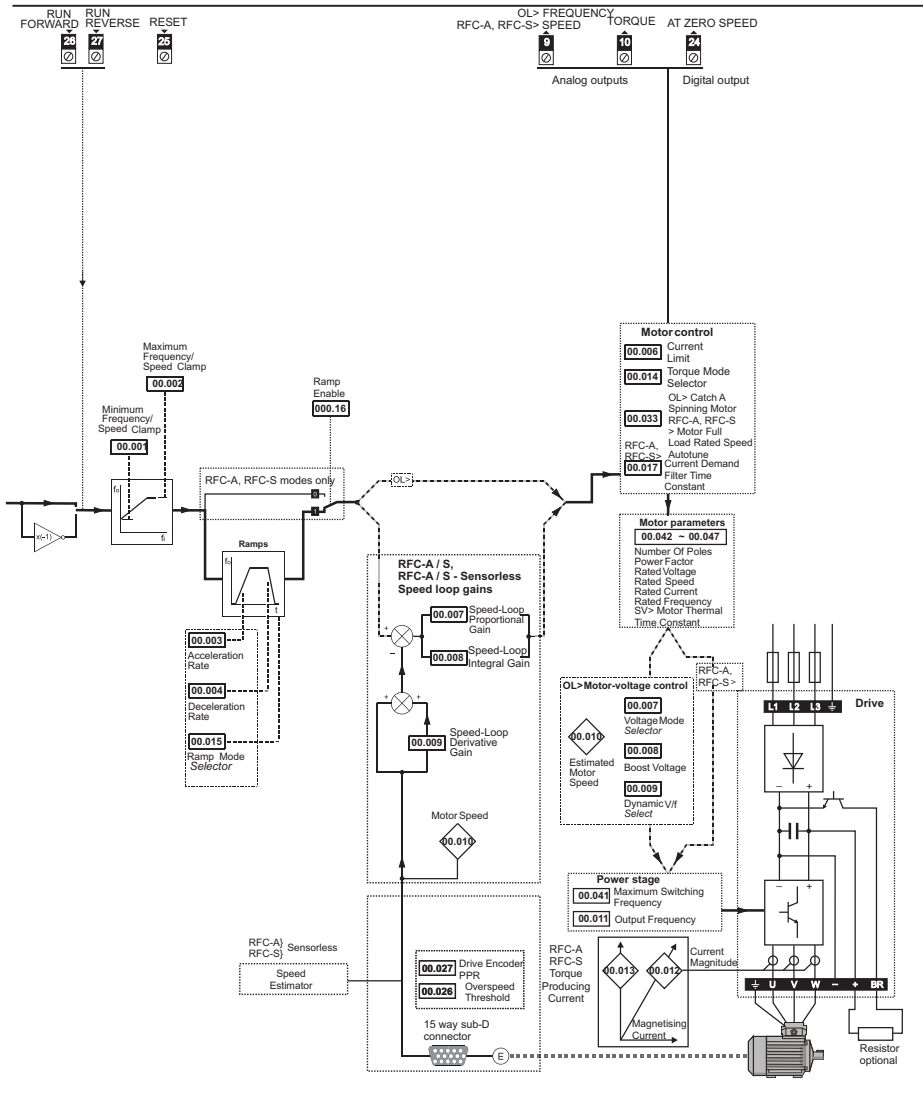

## 6 Running the motor

This chapter takes the new user through all the essential steps to running a motor for the first time, in each of the possible operating modes.



Ensure that no damage or safety hazard could arise from the motor starting unexpectedly.



The values of the motor parameters affect the protection of the motor.

The default values in the drive should not be relied upon.

It is essential that the correct value is entered in Pr **00.046 Rated Current**. This affects the thermal protection of the motor.



If the drive is started using the keypad it will run to the speed defined by the *Keypad*

*Control Mode Reference* (01.017). This may not be acceptable depending on the

application. The user must check in Pr **01.017** and ensure that the keypad reference has been set to 0.



If the intended maximum speed affects the safety of the machinery, additional independent over-speed protection must be used.

### 6.1 Quick start Connections

#### 6.1.1 Basic requirements

This section shows the basic connections which must be made for the drive to run in the required mode. For minimal parameter settings to run in each mode please see the relevant part of the *Drive User Guide*.

**Table 6-1 Minimum control connection requirements for each control mode**

Drive control method	Requirements
Terminal mode	Drive enable Speed / Torque reference Run forward / Run reverse
Keypad mode	Drive enable
Communications	Drive enable Communications link

**Table 6-2 Minimum control connection requirements for each mode of operation**

Operating mode	Requirements
Open loop mode	Induction motor
RFC-A mode (with position feedback)	Induction motor with position feedback
RFC-S mode (with position feedback)	Permanent magnet motor with position feedback

**Figure 6-1 Minimum connections to get the motor running in any operating mode (size 4 illustrated)**

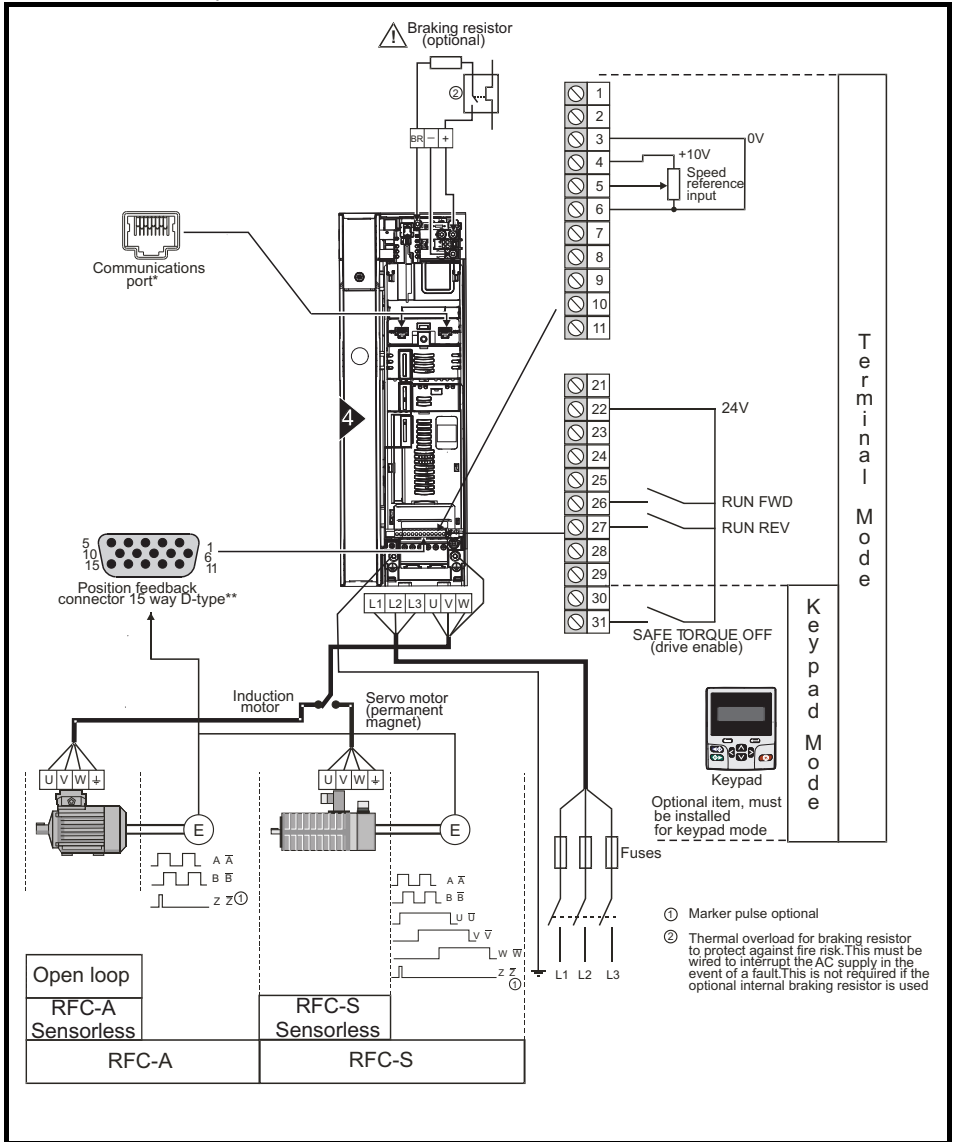



\* Ethernet fieldbus communication ports on *Unidrive M700/HS70* and 485 serial communication ports on *Unidrive M701*.

\*\* Position feedback port (refer to Table 3-1 *P1 position feedback connection details* on page 9).

Safety information
Introduction
Control connections
Getting started
Basic parameters (Menu 0)
<b>Running the motor</b>
Further information

## 6.2 Quick Start / start-up

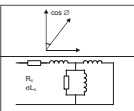



### 6.2.1 Open loop

Action	Detail	
Before power-up	Ensure: <ul style="list-style-type: none"> <li>The drive enable signal is not given (terminal 31)</li> <li>Run signal is not given</li> <li>Motor is connected</li> </ul>	
Power-up the drive	Verify that Open Loop mode is displayed as the drive powers up. Ensure: Drive displays 'Inhibit'	
Enter motor nameplate details	Enter: <ul style="list-style-type: none"> <li>Motor rated frequency in Pr <b>00.047</b> (Hz)</li> <li>Motor rated current in Pr <b>00.046</b> (A)</li> <li>Motor rated speed in Pr <b>00.045</b> (rpm)</li> <li>Motor rated voltage in Pr <b>00.044</b> (V) - check if <math>\Delta</math> or <math>\text{Y}</math> connection</li> </ul>	
Set max frequency	Enter: <ul style="list-style-type: none"> <li>Maximum frequency in Pr <b>00.002</b> (Hz)</li> </ul>	
Set accel. / decel. rates	<ul style="list-style-type: none"> <li>Acceleration rate in Pr <b>00.003</b> (s /100 Hz)</li> <li>Deceleration rate in Pr <b>00.004</b> (s /100 Hz) (If braking resistor installed, set Pr <b>00.015</b> = FAST. Also ensure Pr <b>10.030</b>, Pr <b>10.031</b> and Pr <b>10.061</b> are set correctly, otherwise premature 'Brake R Too Hot' trips may be seen).</li> </ul>	
Motor thermistor set-up	If a thermistor is connected to terminal 8, then the <i>Analog Input 3 Mode</i> (07.015) parameter must be set to Thermistor Short Cct (7), Thermistor (8) or Therm No Trip (9).	
Autotune	<p>The drive is able to perform either a stationary or a rotating autotune. The motor must be at a standstill before an auto-tune is enabled. A rotating autotune should be used whenever possible so the measured value of power factor of the motor is used by the drive</p> <div style="border: 1px solid black; padding: 5px; margin: 10px 0;">  <p>A rotating autotune will cause the motor to accelerate up to <math>\frac{2}{3}</math> base speed in the direction selected regardless of the reference provided. Once complete the motor will coast to a stop. The enable signal must be removed before the drive can be made to run at the required reference.</p> </div> <p><b>To perform an autotune:</b></p> <ul style="list-style-type: none"> <li>Set Pr <b>00.040</b> = 1 for a stationary autotune or set Pr <b>00.040</b> = 2 for a rotating autotune</li> <li>Close the Drive Enable signal (terminal 31). The drive will display 'Ready'.</li> <li>Close the run signal (terminal 26 or 27). The lower display will flash 'Autotune' while the drive is performing the autotune.</li> <li>Wait for the drive to display 'Ready' or 'Inhibit' and for the motor to come to a standstill.</li> <li>Remove the drive enable and run signal from the drive.</li> </ul>	
Save parameters	Select 'Save Parameters' in Pr <b>mm.000</b> (alternatively enter a value of 1000 in Pr <b>mm.000</b> ) and press red  reset button or toggle the reset digital input.	
Run	Drive is now ready to run	

## 6.2.2 RFC-A mode (with position feedback)

### Induction motor with position feedback

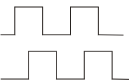
For simplicity only an incremental quadrature encoder will be considered here. For information on setting up one of the other supported speed feedback devices, refer to *Setting up a feedback device* in the *Drive User Guide*.

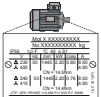
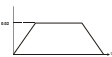
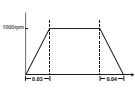
Action	Detail	
Before power-up	Ensure: <ul style="list-style-type: none"> <li>• Drive Enable signal is not given (terminal 31)</li> <li>• Run signal is not given</li> <li>• Motor and feedback device are connected</li> </ul>	
Power-up the drive	<ul style="list-style-type: none"> <li>• Verify that RFC-A mode is displayed as the drive powers up. If the mode is incorrect see section 4.7 <i>Changing the operating mode</i> on page 20.</li> </ul> Ensure: Drive displays 'Inhibit'	
Set motor feedback parameters	<b>Incremental encoder basic set-up</b> Enter: <ul style="list-style-type: none"> <li>• Drive encoder type in Pr <b>03.038</b> = AB (0); Quadrature encoder</li> <li>• Encoder power supply in Pr. <b>03.036</b> = 5 V (0), 8 V (1) or 15 V (2).</li> </ul> <b>NOTE</b> If output voltage from the encoder is >5 V, then the termination resistors must be disabled Pr <b>03.039</b> to 0. <div style="border: 1px solid black; padding: 5px; margin: 10px 0;">  <p>Setting the encoder voltage supply too high for the encoder could result in damage to the feedback device.</p> <p><b>CAUTION</b></p> </div> <ul style="list-style-type: none"> <li>• Drive encoder Lines Per Revolution (LPR) in Pr <b>03.034</b></li> <li>• Drive encoder termination resistor setting in Pr <b>03.039</b>:               <ul style="list-style-type: none"> <li><b>0</b> = A-A\, B-B\, Z-Z\ termination resistors disabled</li> <li><b>1</b> = A-A\, B-B\, termination resistors enabled, Z-Z\ termination resistors disabled</li> <li><b>2</b> = A-A\, B-B\, Z-Z\ termination resistors enabled</li> </ul> </li> </ul>	
Motor thermistor set-up	If a thermistor is connected to terminal 8, then the <i>Analog Input 3 Mode</i> (07.015) parameter must be set to Thermistor Short Cct (7), Thermistor (8) or Therm No Trip (9). <b>NOTE</b> The thermistor input will be disabled until Pr <b>07.015</b> is set to one of the above.	
Enter motor nameplate details	<ul style="list-style-type: none"> <li>• Motor rated frequency in Pr <b>00.047</b> (Hz)</li> <li>• Motor rated current in Pr <b>00.046</b> (A)</li> <li>• Motor rated speed in Pr <b>00.045</b> (rpm)</li> <li>• Motor rated voltage in Pr <b>00.044</b> (V) - check if <math>\Delta</math> or <math>\Lambda</math> connection</li> </ul>	
Set max speed	Enter: <ul style="list-style-type: none"> <li>• Maximum speed in Pr <b>00.002</b> (rpm)</li> </ul>	
Set accel / decel rates	Enter: <ul style="list-style-type: none"> <li>• Acceleration rate in Pr <b>00.003</b> (s/1000 rpm)</li> <li>• Deceleration rate in Pr <b>00.004</b> (s/1000 rpm) (If braking resistor installed, set Pr <b>00.015</b> = FAST. Also ensure Pr <b>10.030</b>, Pr <b>10.031</b> and Pr <b>10.061</b> are set correctly, otherwise premature 'Brake R Too Hot' trips may be seen).</li> </ul>	

Safety information

Introduction



Control connections

Getting started

Basic parameters  
(Menu 0)



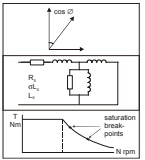

Running the motor

Further information

Action	Detail	
Autotune	<p>The drive is able to perform either a stationary or a rotating autotune. The motor must be at a standstill before an autotune is enabled. A stationary autotune will give moderate performance whereas a rotating autotune will give improved performance as it measures the actual values of the motor parameters required by the drive.</p> <div data-bbox="210 268 834 391" style="border: 1px solid black; padding: 5px;">  <p>A rotating autotune will cause the motor to accelerate up to <math>\frac{2}{3}</math> base speed in the direction selected regardless of the reference provided. Once complete the motor will coast to a stop. The enable signal must be removed before the drive can be made to run at the required reference.</p> </div> <p><b>To perform an autotune:</b></p> <ul style="list-style-type: none"> <li>• Set Pr <b>00.040</b> = 1 for a stationary autotune or set Pr <b>00.040</b> = 2 for a rotating autotune</li> <li>• Close the drive enable signal (terminal 31). The drive will display 'Ready'.</li> <li>• Close the run signal (terminal 26 or 27). The lower display will flash 'Autotune' while the drive is performing the autotune.</li> <li>• Wait for the drive to display 'Ready' or 'Inhibit' and for the motor to come to a standstill</li> <li>• Remove the drive enable and run signal from the drive.</li> </ul>	
Save parameters	<p>Select 'Save Parameters' in Pr <b>mm.000</b> (alternatively enter a value of 1000 in Pr <b>mm.000</b>) and press red  reset button or toggle the reset digital input.</p>	
Run	<p>Drive is now ready to run</p> 	

## 6.2.3 RFC-A mode (Sensorless control)

### Induction motor with sensorless control

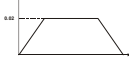
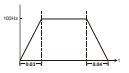
Action	Detail	
Before power-up	Ensure: <ul style="list-style-type: none"> <li>The drive enable signal is not given (terminal 31)</li> <li>Run signal is not given</li> <li>Motor is connected</li> </ul>	
Power-up the drive	Verify that RFC-A mode is displayed as the drive powers up. If the mode is incorrect see section 4.7 <i>Changing the operating mode</i> on page 20. Ensure: Drive displays 'Inhibit'	
Select RFC-A (Sensorless control) mode	<ul style="list-style-type: none"> <li>Set Pr <b>03.024</b> = 1 or 3 to select RFC-A Sensorless mode</li> <li>Set Pr <b>03.040</b> = 0000 to disable the wire break</li> </ul>	
Motor thermistor set-up	If a thermistor is connected to terminal 8, then the <i>Analog Input 3 Mode</i> (07.015) parameter must be set to Thermistor Short Cct (7), Thermistor (8) or Therm No Trip (9). <b>NOTE</b> The thermistor input will be disabled until Pr <b>07.015</b> is set to one of the above.	
Enter motor nameplate details	<ul style="list-style-type: none"> <li>Motor rated frequency in Pr <b>00.047</b> (Hz)</li> <li>Motor rated current in Pr <b>00.046</b> (A)</li> <li>Motor rated speed in Pr <b>00.045</b> (rpm)</li> <li>Motor rated voltage in Pr <b>00.044</b> (V) - check if <math>\Delta</math> or <math>\Lambda</math> connection</li> </ul>	
Set max speed	Enter: <ul style="list-style-type: none"> <li>Maximum frequency in Pr <b>00.002</b> (rpm)</li> </ul>	
Set accel. / decel. rates	<ul style="list-style-type: none"> <li>Acceleration rate in Pr <b>00.003</b> (s /1000 rpm)</li> <li>Deceleration rate in Pr <b>00.004</b> (s /1000 rpm) (If braking resistor installed, set Pr <b>00.015</b> = FAST. Also ensure Pr <b>10.030</b>, Pr <b>10.031</b> and Pr <b>10.061</b> are set correctly).</li> </ul>	
Select or deselect catch a spinning motor mode	If catch a spinning motor mode is not required then set Pr <b>06.009</b> to 0. If catch a spinning motor mode is required then leave Pr <b>06.009</b> at the default of 1, but depending on the size of the motor the value in Pr <b>05.040</b> may need to be adjusted. Pr <b>05.040</b> defines a scaling function used by the algorithm that detects the speed of the motor. The default value of Pr <b>05.040</b> is 1 which is suitable for small motors (<4 kW). For larger motors the value in Pr <b>05.040</b> will need to be increased.	

Safety information

Introduction



Control connections

Getting started

Basic parameters (Menu 0)

Running the motor

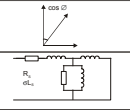
Further information

Action	Detail	
Autotune	<p>The drive is able to perform either a stationary or a rotating autotune. The motor must be at a standstill before an autotune is enabled. A stationary autotune will give moderate performance whereas a rotating autotune will give improved performance as it measures the actual values of the motor parameters required by the drive.</p> <p><b>NOTE</b> It is highly recommended that a rotating autotune is performed (Pr <b>00.040</b> set to 2).</p> <div data-bbox="221 331 865 496" style="border: 1px solid black; padding: 5px;">  <p>A rotating autotune will cause the motor to accelerate up to <math>2/3</math> base speed in the direction selected regardless of the reference provided. Once complete the motor will coast to a stop. The enable signal must be removed before the drive can be made to run at the required reference. The drive can be stopped at any time by removing the run signal or removing the drive enable.</p> </div> <p><b>To perform an auto-tune:</b></p> <ul style="list-style-type: none"> <li>Set Pr <b>00.040</b> = 1 for a stationary autotune or set Pr <b>00.040</b> = 2 for a rotating autotune.</li> <li>Close the drive enable signal (terminal 31). The drive will display 'Ready' or 'Inhibit'.</li> <li>Close the run signal (terminal 26 or 27). The lower display will flash 'Autotune' while the drive is performing the autotune.</li> <li>Wait for the drive to display 'Ready' or 'Inhibit' and for the motor to come to a standstill.</li> <li>Remove the drive enable and run signal from the drive.</li> </ul>	
Save parameters	Select 'Save Parameters' in Pr <b>mm.000</b> (alternatively enter a value of 1000 in Pr <b>mm.000</b> ) and press red  reset button or toggle the reset digital input.	
Run	Drive is now ready to run 	



## 6.2.4 RFC-S mode (with position feedback)

### Permanent magnet motor with a position feedback

For simplicity only an incremental quadrature encoder with commutation outputs will be considered here. For information on setting up one of the other supported speed feedback devices, refer to *Setting up a feedback device* in the *Drive User Guide*.

Action	Detail	
Before power-up	Ensure: <ul style="list-style-type: none"> <li>The drive enable signal is not given (terminal 31)</li> <li>Run signal is not given</li> <li>Motor and feedback device are connected</li> </ul>	
Power-up the drive	Verify that RFC-S mode is displayed as the drive powers up. If the mode is incorrect see section 4.7 <i>Changing the operating mode</i> on page 20 Ensure: Drive displays 'inhibit'	
Set motor feedback parameters	<b>Incremental encoder basic set-up</b> Enter: <ul style="list-style-type: none"> <li>Drive encoder type in Pr. <b>03.038</b> = AB Servo (3): Quadrature encoder with commutation outputs</li> <li>Encoder power supply in Pr. <b>03.036</b> = 5 V (0), 8 V (1) or 15 V (2).</li> </ul> <b>NOTE</b> If output voltage from the encoder is >5 V, then the termination resistors must be disabled Pr <b>03.039</b> to 0. <div style="border: 1px solid black; padding: 5px; margin: 10px 0;">  <p>Setting the encoder voltage supply too high for the encoder could result in damage to the feedback device</p> </div> <ul style="list-style-type: none"> <li>Drive encoder Pulses Per Revolution in Pr <b>03.034</b> (set according to encoder)</li> <li>Drive encoder termination resistor setting in Pr <b>03.039</b>:               <ul style="list-style-type: none"> <li><b>0</b> = A-A\, B-B\, Z-Z\ termination resistors disabled</li> <li><b>1</b> = A-A\, B-B\, termination resistors enabled, Z-Z\ termination resistors disabled</li> <li><b>2</b> = A-A\, B-B\, Z-Z\ termination resistors enabled</li> </ul> </li> </ul>	
Motor thermistor set-up	At factory default, terminal 8 is set-up for an analog voltage input. If a thermistor is connected to terminal 8, then the <i>Analog Input 3 Mode</i> (07.015) parameter must be set to Thermistor Short Cct (7), Thermistor (8) or Therm No Trip (9). <b>NOTE</b> The thermistor input will be disabled until Pr <b>07.015</b> is set to one of the above.	
Enter motor nameplate details	Enter: <ul style="list-style-type: none"> <li>Motor rated current in Pr <b>00.046</b> (A)                Ensure that this equal to or less than the Heavy Duty rating of the drive otherwise 'Motor Too Hot' trips may occur during the autotune.</li> <li>Number of poles in Pr <b>00.042</b></li> <li>Motor rated voltage in Pr <b>00.044</b> (V)</li> </ul>	
Set maximum speed	Enter: <ul style="list-style-type: none"> <li>Maximum speed in Pr <b>00.002</b> (rpm)</li> </ul>	

Safety information

Introduction





Control connections

Getting started

Basic parameters  
(Menu 0)

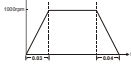
Running the motor

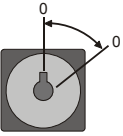
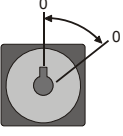
Further information

Action	Detail	
Set accel / decel rates	<ul style="list-style-type: none"> <li>Acceleration rate in Pr <b>00.003</b> (s/1000 rpm)</li> <li>Deceleration rate in Pr <b>00.004</b> (s/1000 rpm) (If braking resistor installed, set Pr <b>00.015</b> = Fast. Also ensure Pr <b>10.030</b>, Pr <b>10.031</b> and Pr <b>10.061</b> are set correctly, otherwise premature 'Brake R Too Hot' trips may be seen).</li> </ul>	
Autotune	<p>The drive is able to perform either a stationary or a rotating autotune. The motor must be at a standstill before an autotune is enabled. A stationary autotune will give moderate performance whereas a rotating autotune will give improved performance as it measures the actual values of the motor parameters required by the drive. The drive is able to perform a stationary, rotating, mechanical load measurement or locked rotor test autotune. The motor must be at a standstill before an autotune is enabled. It is suggested that a rotating autotune is used for accurate measurement for position feedback phase angle.</p> <div style="border: 1px solid black; padding: 5px; margin-top: 10px;">  <p>The rotating autotune will rotate the motor by up to 2 mechanical revolutions in the direction selected, regardless of the reference provided. After a short delay, the motor is further rotated through a electrical revolution. The enable signal must be removed before the drive can be made to run at the required reference. The drive can be stopped at any time by removing the run signal or removing the drive enable.</p> </div>	
Autotune (cont)	<p><b>To perform an autotune:</b></p> <ul style="list-style-type: none"> <li>Set Pr <b>00.040</b> = 1 for a stationary autotune, Pr <b>00.040</b> = 2 for a rotating autotune.</li> <li>Close the run signal (terminal 26 or 27).</li> <li>Close the drive enable signal (terminal 31). The lower display will flash 'Autotune' while the drive is performing the test.</li> <li>Wait for the drive to display 'Ready' or 'Inhibit' and for the motor to come to a standstill.</li> </ul> <p>If the drive trips it cannot be reset until the drive enable signal (terminal 31) has been removed.</p> <ul style="list-style-type: none"> <li>Remove the drive enabled and run signal from the drive.</li> </ul>	
Save parameters	Select 'Save Parameters' in Pr <b>mm.000</b> (alternatively enter a value of 1000 in Pr <b>mm.000</b> ) and press red  reset button or toggle the reset digital input.	
Run	Drive is now ready to run	

## 6.2.5 RFC-S mode (Sensorless) Permanent magnet motor without position feedback

Action	Detail	
Before power-up	Ensure: <ul style="list-style-type: none"> <li>The drive enable signal is not given (terminal 31).</li> <li>Run signal is not given</li> <li>Motor is connected</li> </ul>	
Power-up the drive	Verify that RFC-S mode is displayed as the drive powers up. If the mode is incorrect see section 4.7 <i>Changing the operating mode</i> on page 20, otherwise restore parameter defaults (see section 4.9 <i>Restoring parameter defaults</i> on page 21). Ensure that the drive displays 'inhibit'	
Enter motor nameplate details	Enter: <ul style="list-style-type: none"> <li>Motor rated current in Pr <b>00.046</b> (A) Ensure that this equal to or less than the Heavy Duty rating of the drive otherwise 'Motor Too Hot' trips may occur during the autotune.</li> <li>Number of poles in Pr <b>00.042</b></li> <li>Motor rated voltage in Pr <b>00.044</b> (V)</li> </ul>	
Set maximum speed	Enter: <ul style="list-style-type: none"> <li>Maximum speed in Pr <b>00.002</b> (rpm)</li> </ul>	
Set acceleration / deceleration rates	Enter: <ul style="list-style-type: none"> <li>Acceleration rate in Pr <b>00.003</b> (s/1000 rpm)</li> <li>Deceleration rate in Pr <b>00.004</b> (s/1000 rpm) (If braking resistor installed, set Pr <b>00.015</b> = Fast. Also ensure Pr <b>10.030</b>, Pr <b>10.031</b> and Pr <b>10.061</b> are set correctly, otherwise premature 'Brake R Too Hot' trips may be seen).</li> </ul>	
Autotune	The drive is able to perform a stationary autotune. The motor must be at a standstill before an autotune is enabled. A stationary autotune will give moderate performance. <ul style="list-style-type: none"> <li>A stationary autotune is performed to locate the flux axis of the motor. The stationary autotune measures the stator resistance, inductance in flux axis, inductance in torque axis with no load on the motor and values relating to deadtime compensation from the drive. Measured values are used to calculate the current loop gains, and at the end of the test the values in Pr <b>00.038</b> and Pr <b>00.039</b> are updated.</li> </ul> To perform an autotune: <ul style="list-style-type: none"> <li>Set Pr <b>00.040</b> = 1 or 2 for a stationary autotune. (Both perform the same tests).</li> <li>Close the run signal (terminal 26 or 27).</li> <li>Close the drive enable signal (terminal 31). The upper row of the display will flash 'Auto Tune' during the test.</li> <li>Wait for the drive to display 'Ready' or 'Inhibit'.</li> </ul> If the drive trips it cannot be reset until the drive enable signal (terminal 31) has been removed. <ul style="list-style-type: none"> <li>Remove the drive enabled and run signal from the drive.</li> </ul>	
Check Saliency	In sensorless mode, when the motor speed is below Pr <b>00.045</b> / 10, a special low speed algorithm must be used to control the motor. There are two modes available, with the mode chosen based on the saliency of the motor. The ratio No-load Lq (Pr <b>00.056</b> ) / Ld (Pr <b>05.024</b> ) provides a measure of the saliency. If this value is > 1.1, then Non-salient mode must be used (this is the default), otherwise Injection mode may be used. Set Pr <b>00.054</b> for the selected mode: Injection (0) or Non-salient (1).	
Save parameters	Select 'Save Parameters' in Pr <b>mm.000</b> (alternatively enter a value of 1000 in Pr <b>mm.000</b> ) and press red  reset button or toggle the reset digital input.	
Run	Drive is now ready to run	

Safety information

Introduction

Control connections

Getting started

Basic parameters  
(Menu 0)

Running the motor

Further information

## 6.2.6 Use of the motor database for a Leroy Somer LSRPM motor for use in RFC-S Sensorless mode.

Select 'Motor Setup' from the 'Dashboard'.

On the 'Motor Setup' screen, select 'Choose a motor'.

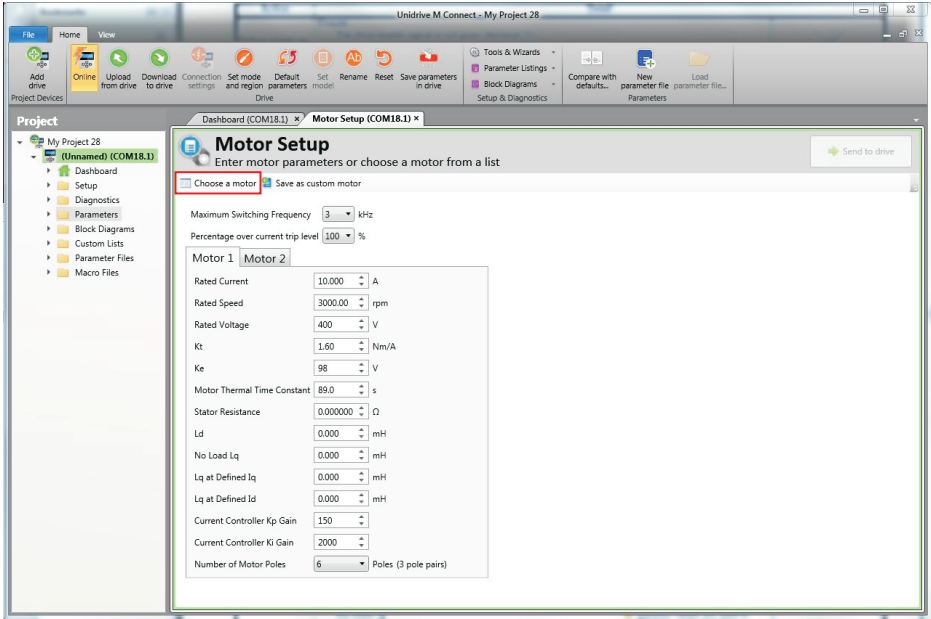

Select the required motor database:

Select the required motor from the list and click 'OK'.

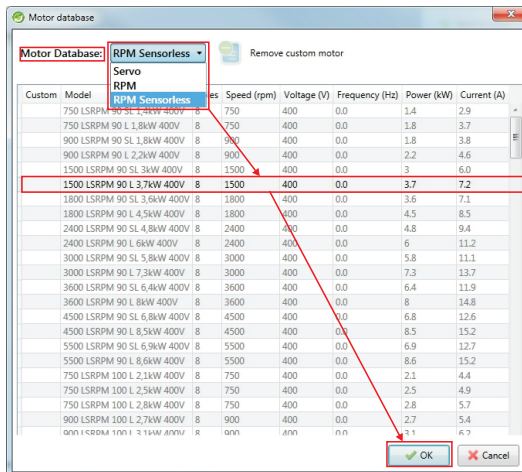

The data for the selected motor is displayed on the 'Motor Setup' screen. Click 'Send to drive' to set the associated parameters.

It is possible to set motor parameters for motor 2, by selecting the 'Motor 2' tab and following the same procedure.

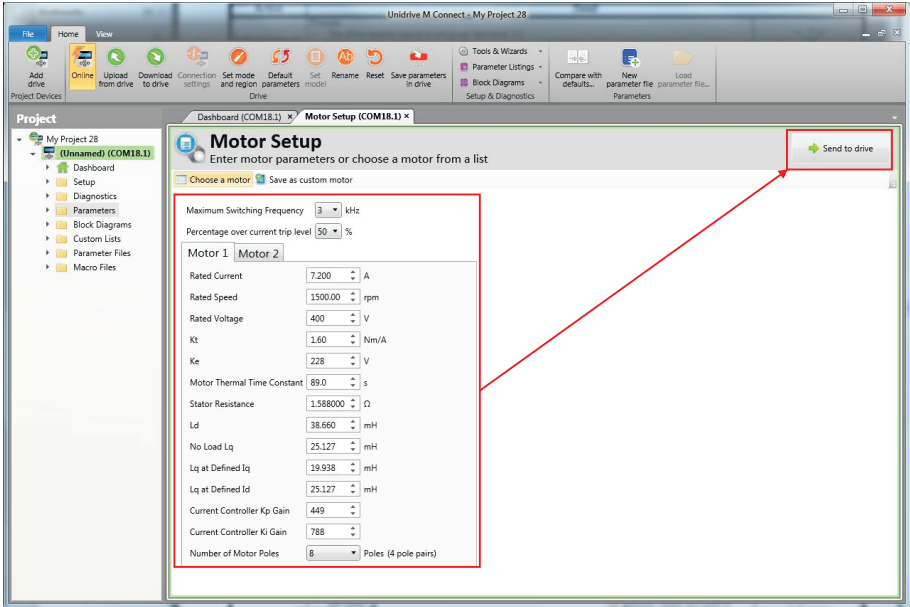

---

## 7 Further information

---

### 7.1 Diagnostics

For further information on diagnostics including trips and alarms, refer to the *Drive User Guide*.



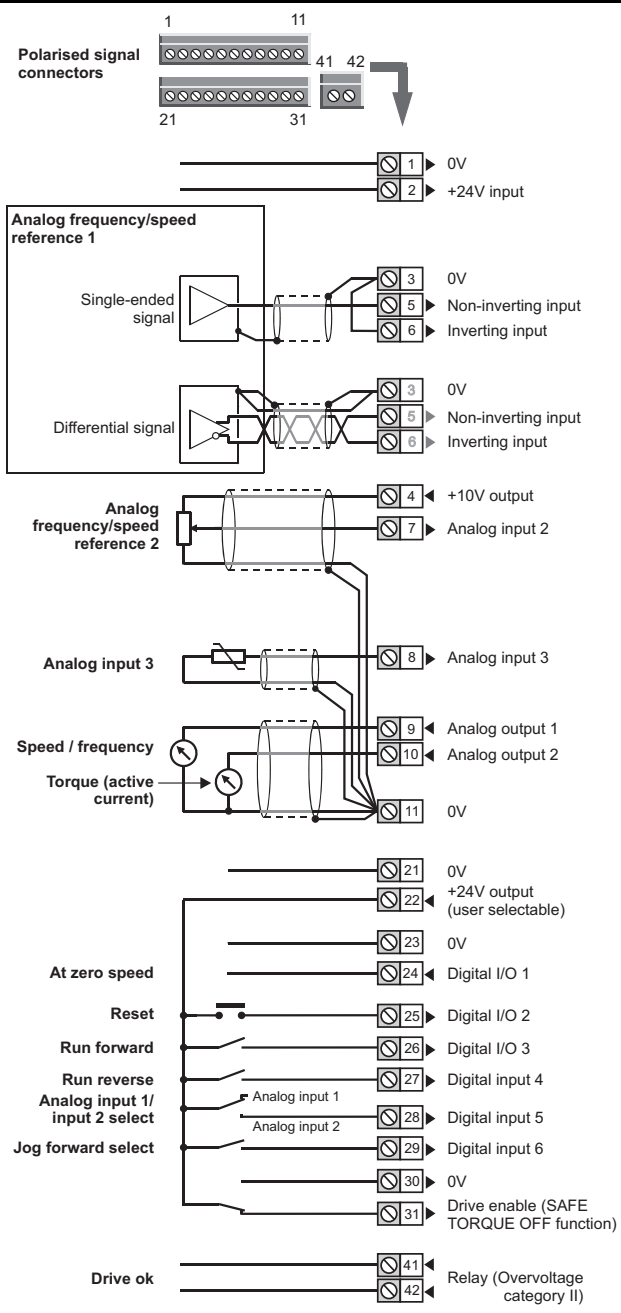

0478-0239-02